

 DIGITAL DESIGNER 4.2

Model Name:
Modell

Number of Bricks: **436**

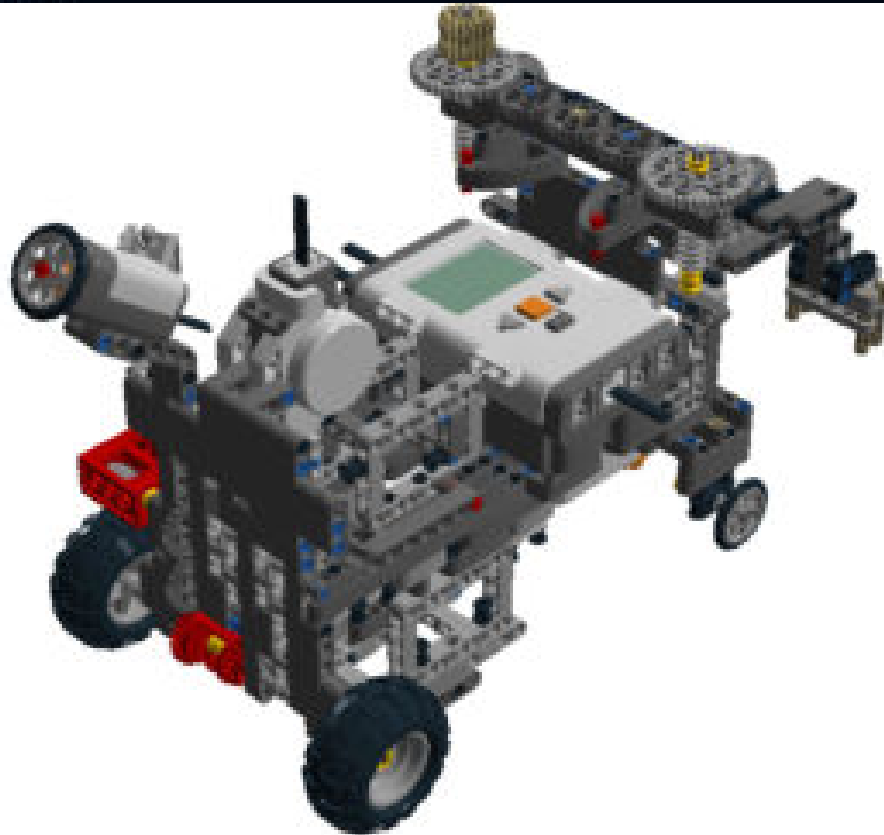

Step 1 of 159

1 x



2 x



Step 2 of 159

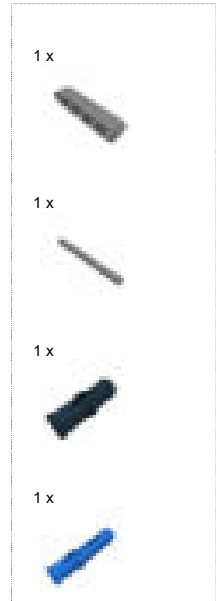

Step 3 of 159

1 x

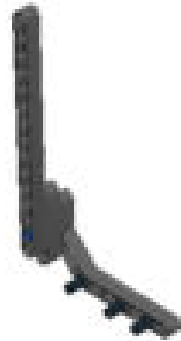
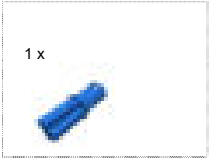

Step 4 of 159

1 x



1 x



1 x



Step 5 of 159

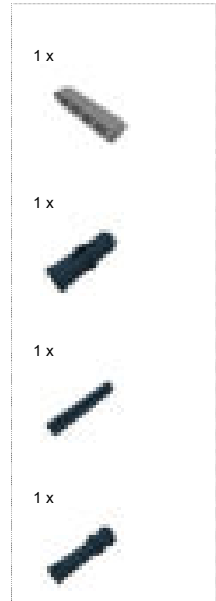

Step 6 of 159

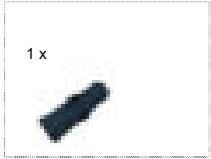

Step 7 of 159

1 x



1 x



Step 8 of 159



Step 9 of 159

1 x



1 x



Step 10 of 159

1 x



1 x



Step 11 of 159



Step 12 of 159

1 x

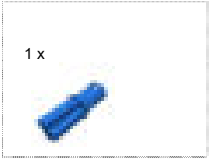

Step 13 of 159

1 x



1 x



Step 14 of 159

1 x



1 x



2 x



Step 15 of 159



Step 16 of 159



Step 17 of 159

1 x



1 x



1 x



Step 18 of 159



Step 19 of 159

1 x



2 x



Step 20 of 159

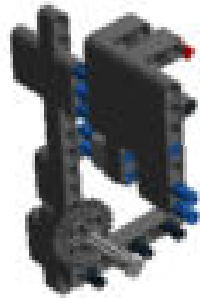
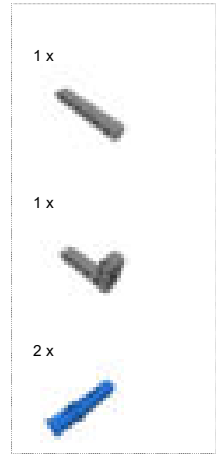

Step 21 of 159

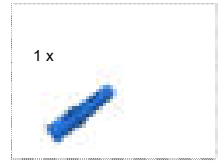

Step 22 of 159

1 x



2 x



Step 23 of 159

1 x



2 x

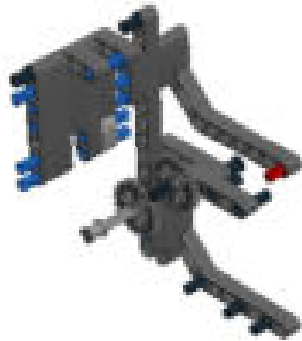

Step 24 of 159

1 x



1 x



Step 25 of 159



Step 26 of 159

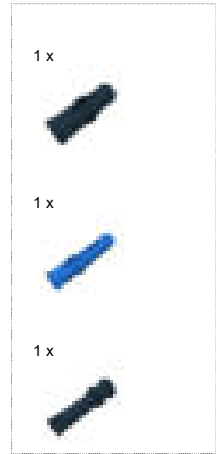

Step 27 of 159

1 x



1 x



1 x



1 x



Step 28 of 159

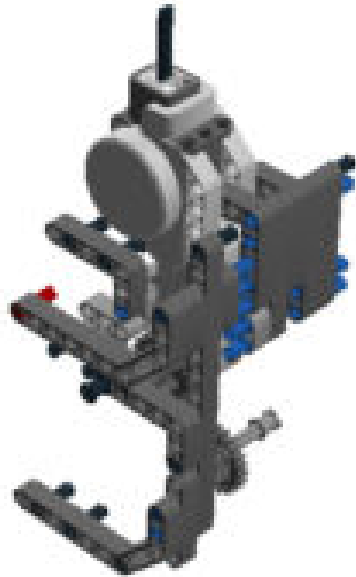

Step 29 of 159



Step 30 of 159

1 x



2 x



Step 31 of 159



Step 32 of 159

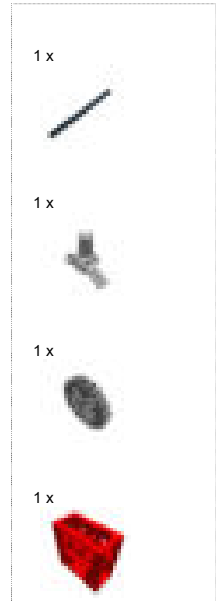

Step 33 of 159



Step 34 of 159

1 x



1 x



1 x



1 x



Step 35 of 159



Step 36 of 159

1 x



1 x



Step 37 of 159



Step 38 of 159

1 x



1 x



1 x



1 x



Step 39 of 159

1 x



1 x



1 x



Step 40 of 159



Step 41 of 159

1 x



2 x



Step 42 of 159



Step 43 of 159

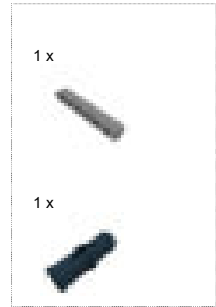

Step 44 of 159



Step 45 of 159



Step 46 of 159

1 x



2 x



1 x



Step 47 of 159

2 x



1 x



1 x



Step 48 of 159



Step 49 of 159

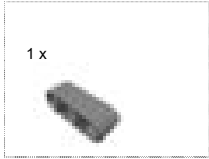

Step 50 of 159

1 x



1 x



2 x



Step 51 of 159

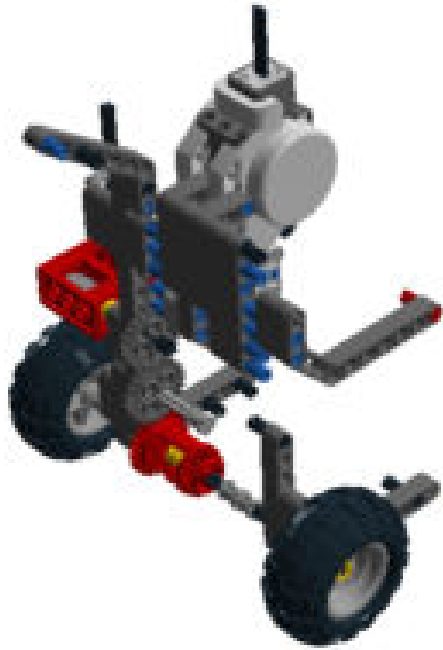

Step 52 of 159

1 x



1 x

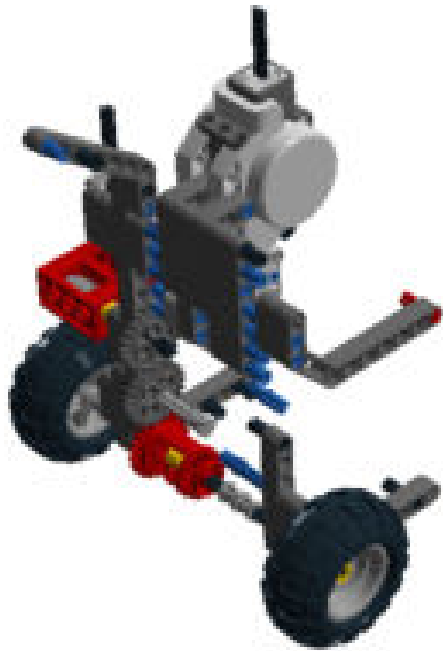

Step 53 of 159

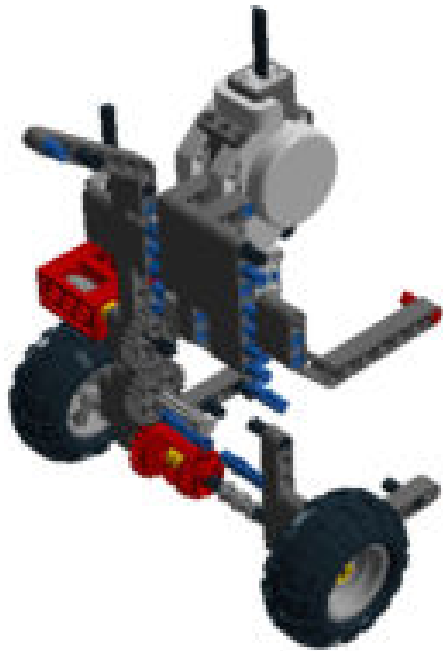

Step 54 of 159

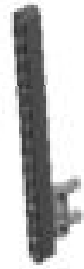
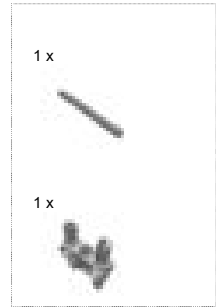

Step 55 of 159

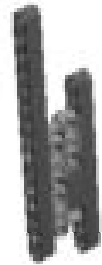
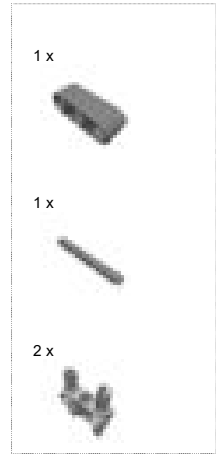

Step 56 of 159

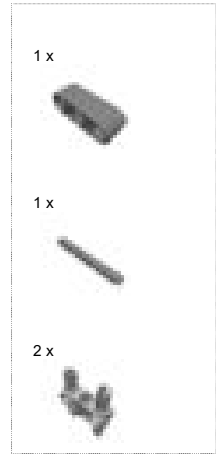

Step 57 of 159

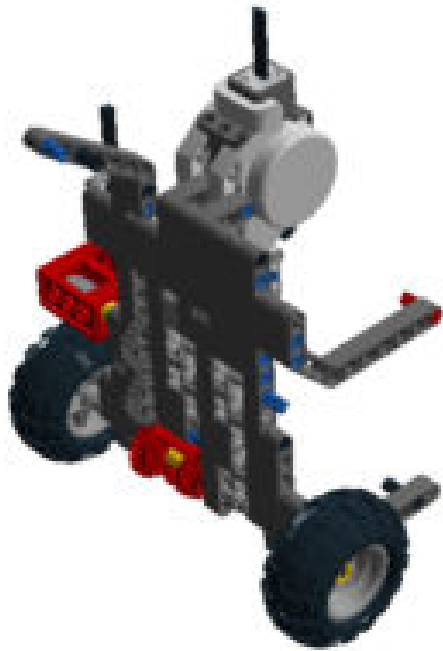

Step 58 of 159



Step 59 of 159

1 x



1 x



1 x



1 x



Step 60 of 159



Step 61 of 159

1 x

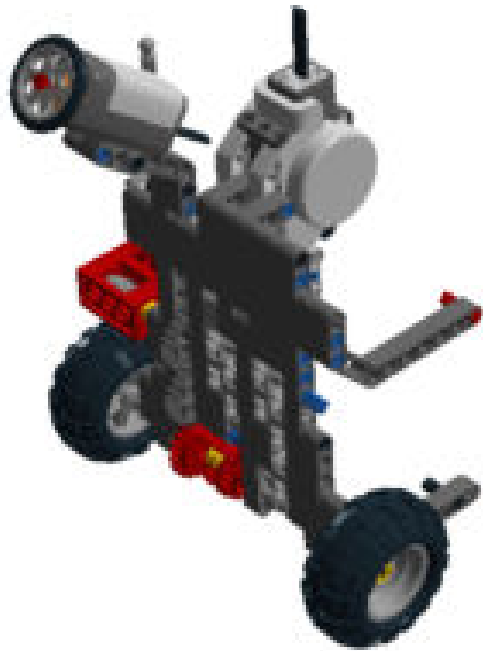
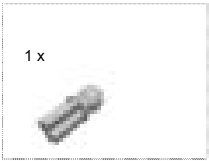

Step 62 of 159

1 x

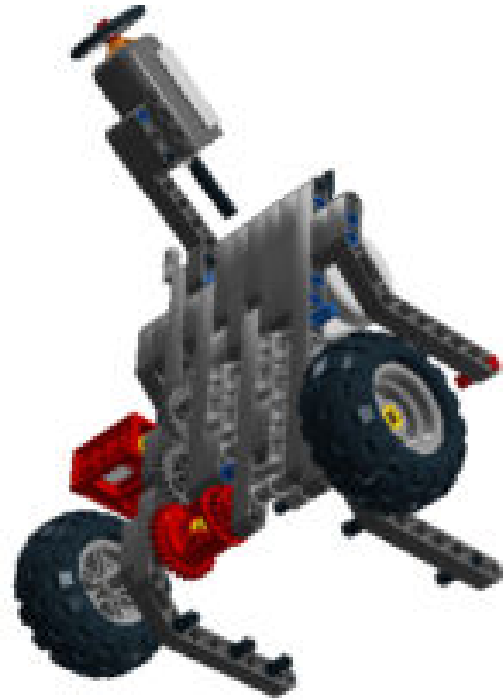
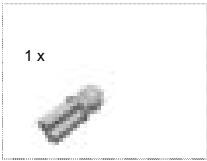

Step 63 of 159

1 x



2 x



Step 64 of 159

2 x



1 x



1 x



Step 65 of 159

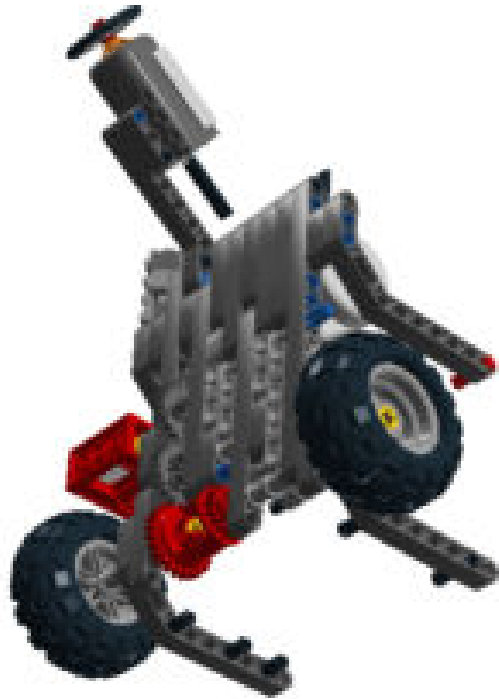

Step 66 of 159

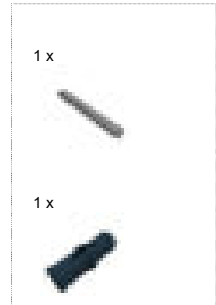

Step 67 of 159

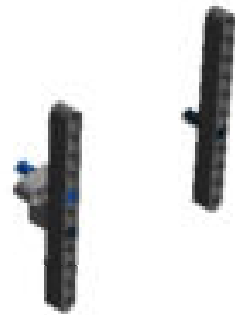
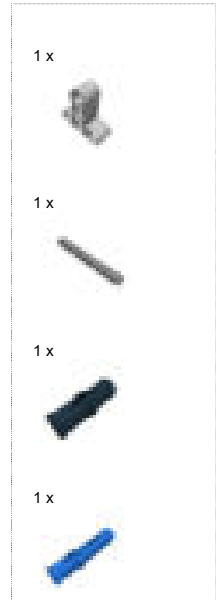

Step 68 of 159

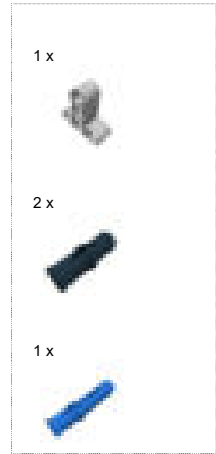

Step 69 of 159

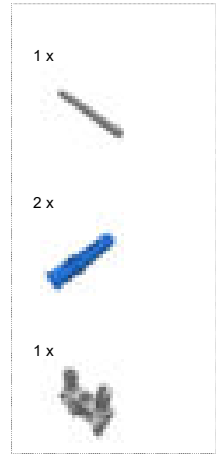

Step 70 of 159

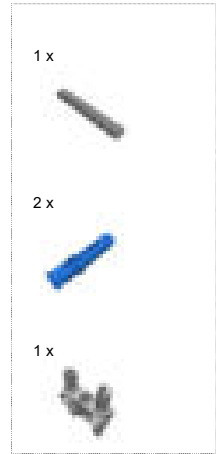

Step 71 of 159

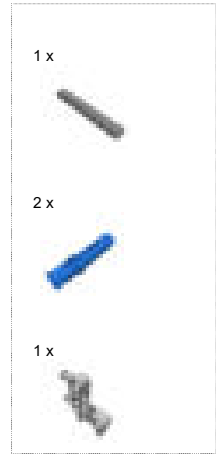

Step 72 of 159

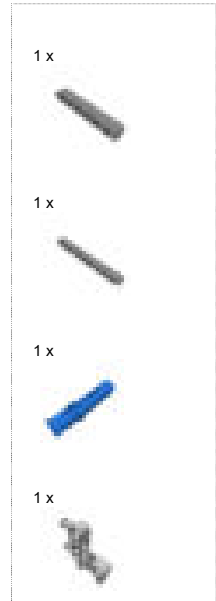

Step 73 of 159

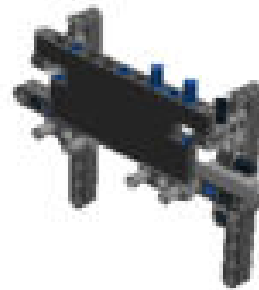
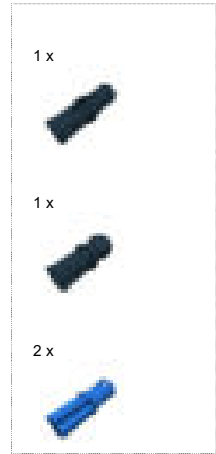

Step 74 of 159

1 x



1 x



1 x



1 x





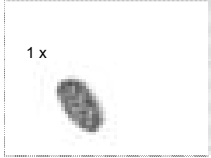

Step 75 of 159

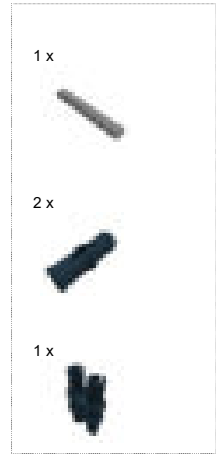

Step 76 of 159



Step 77 of 159

- 1 x 
- 1 x 
- 1 x 
- 1 x 



Step 78 of 159

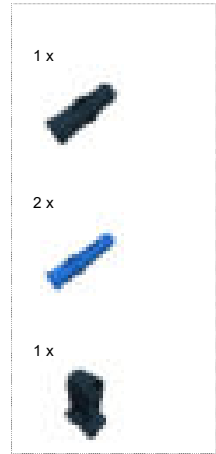

Step 79 of 159

1 x



1 x



1 x



Step 80 of 159

2 x



2 x



Step 81 of 159

2 x



1 x



1 x



Step 82 of 159

1 x



3 x



Step 83 of 159

1 x



1 x



1 x



1 x

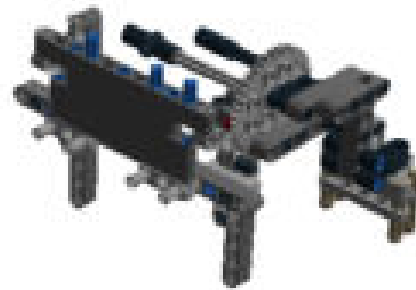

Step 84 of 159

2 x



2 x



Step 85 of 159

2 x





1 x



1 x



Step 86 of 159

- 1 x 
- 2 x 
- 1 x 



Step 87 of 159

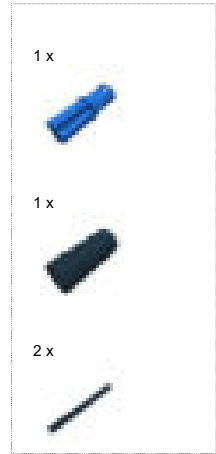

Step 88 of 159

1 x



1 x







1 x



1 x



Step 89 of 159

- 1 x 
- 1 x 
- 1 x 
- 1 x 



Step 90 of 159

1 x



2 x

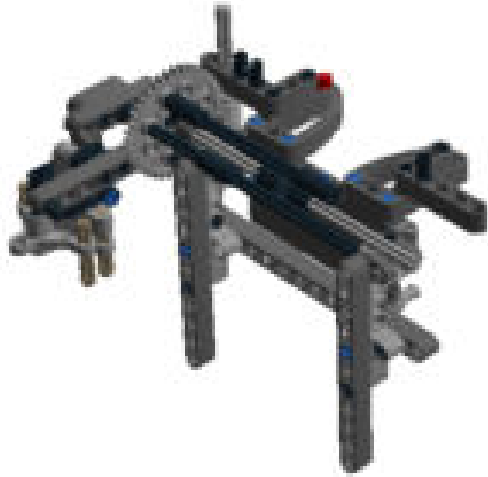

Step 91 of 159

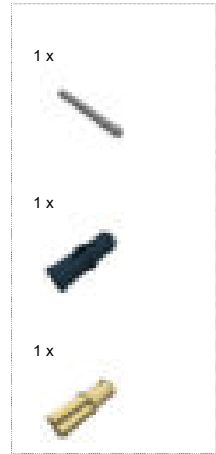

Step 92 of 159

1 x



1 x



2 x



Step 93 of 159

1 x



1 x



1 x



1 x



Step 94 of 159

1 x



1 x

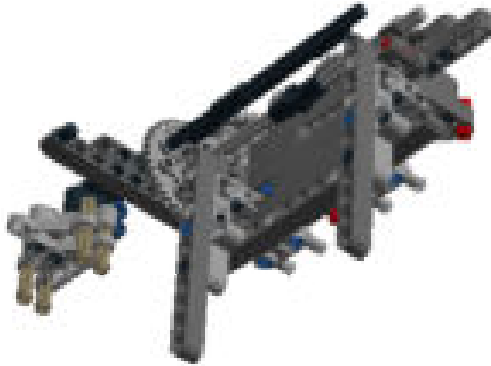

Step 95 of 159

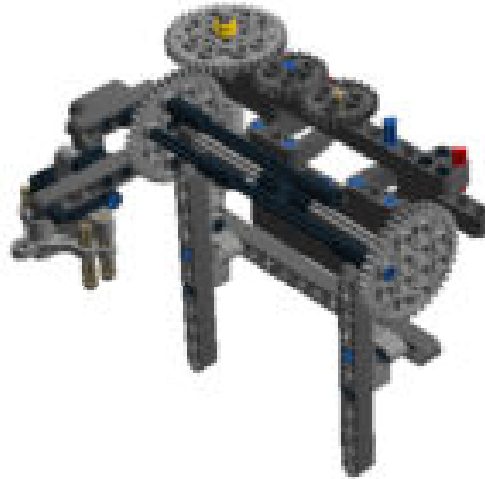
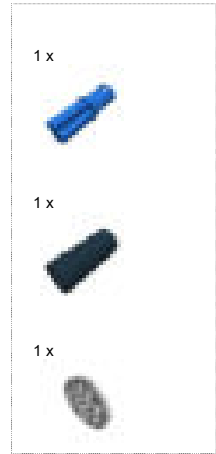

Step 96 of 159

2 x



1 x



1 x

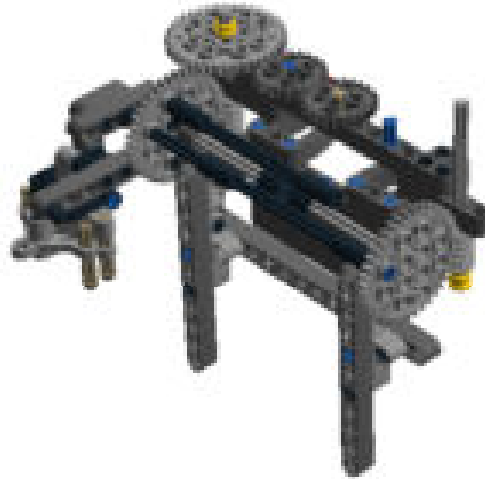

Step 97 of 159

2 x



1 x



1 x



Step 98 of 159

1 x



2 x



1 x



Step 99 of 159

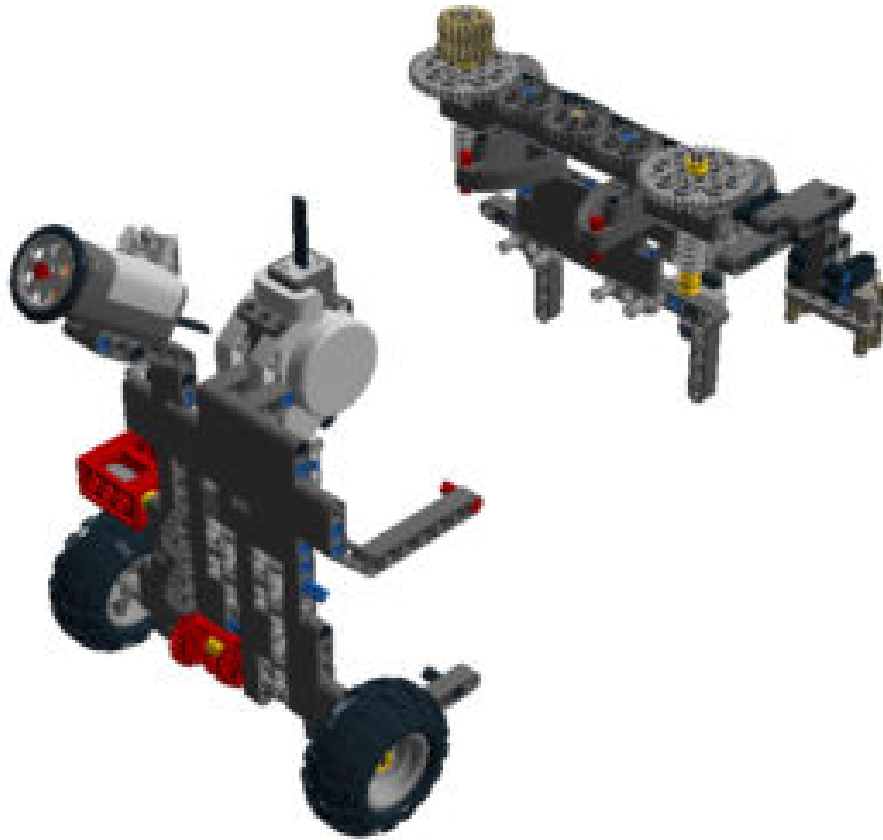

Step 100 of 159

1 x



1 x



Step 101 of 159

1 x



2 x



1 x



Step 102 of 159

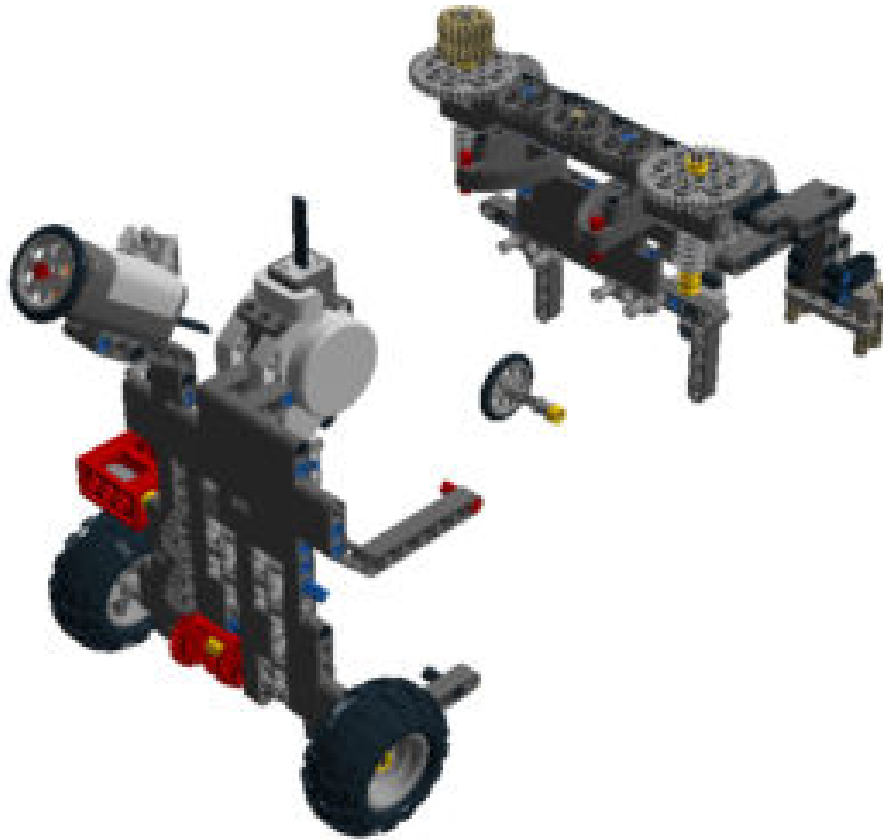

Step 103 of 159

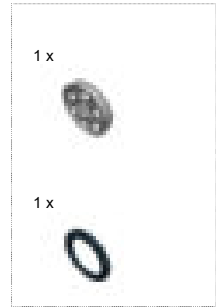

Step 104 of 159

1 x



2 x



1 x



Step 105 of 159

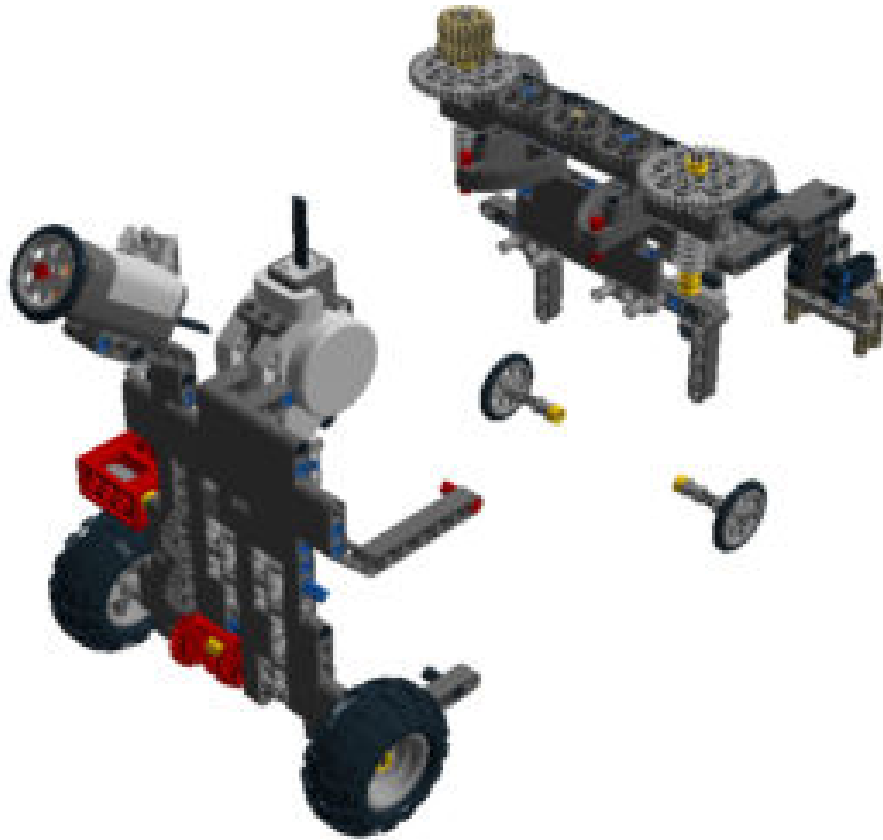

Step 106 of 159

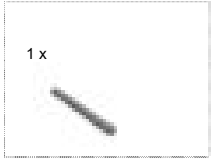

Step 107 of 159

2 x



2 x



Step 108 of 159

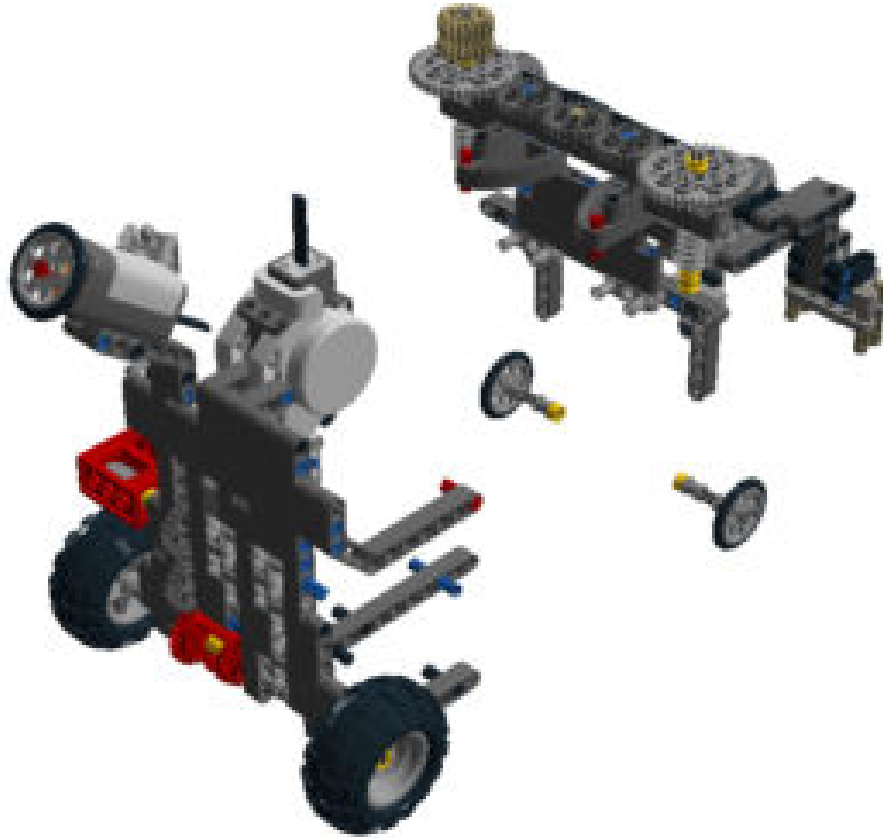

Step 109 of 159

1 x



1 x



2 x



Step 110 of 159

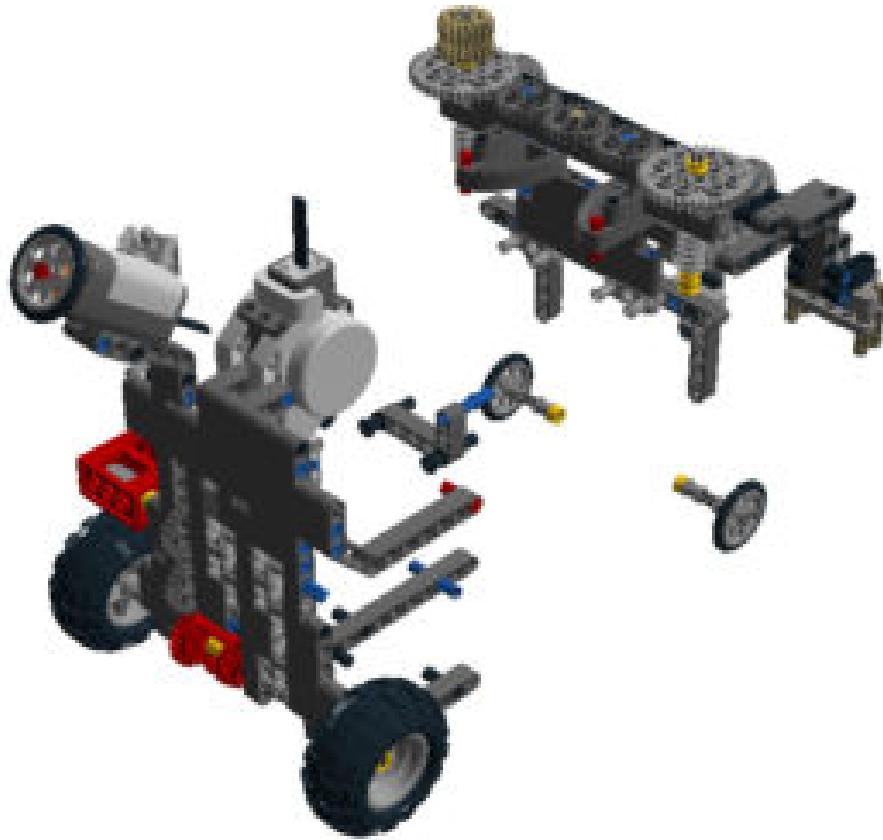

Step 111 of 159

1 x



1 x



1 x



Step 112 of 159

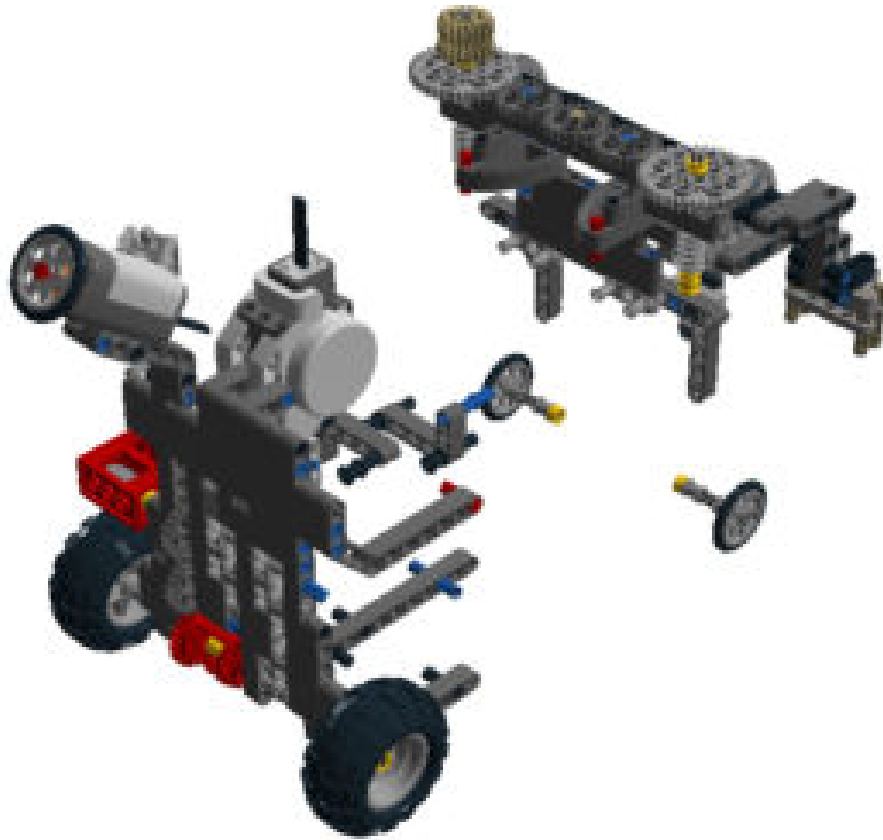

Step 113 of 159

2 x

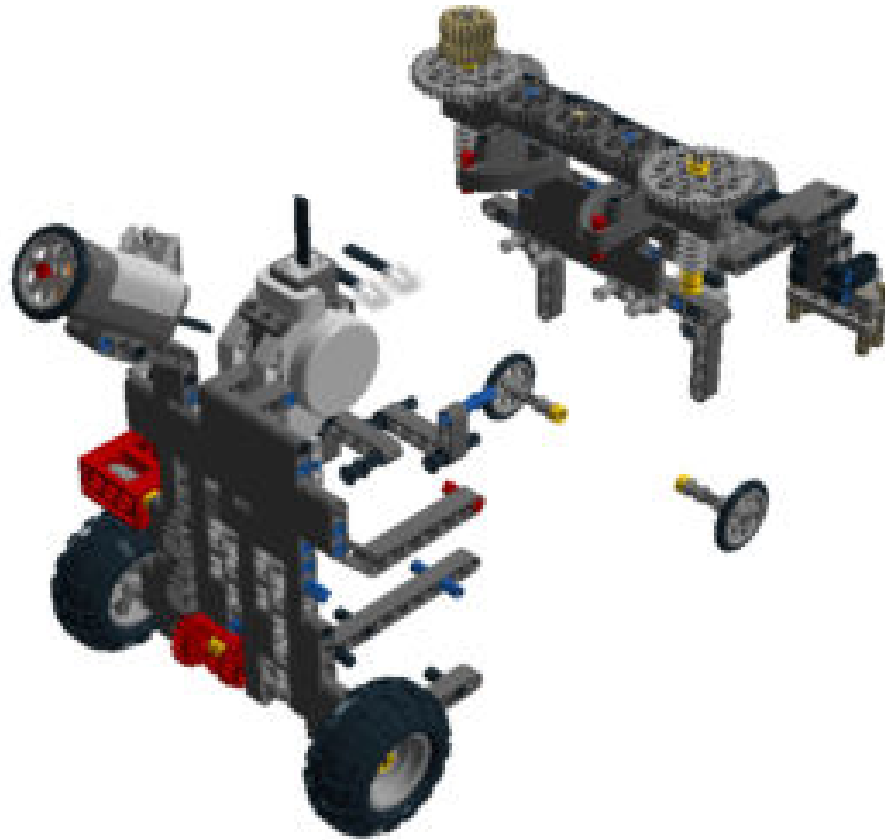

Step 114 of 159

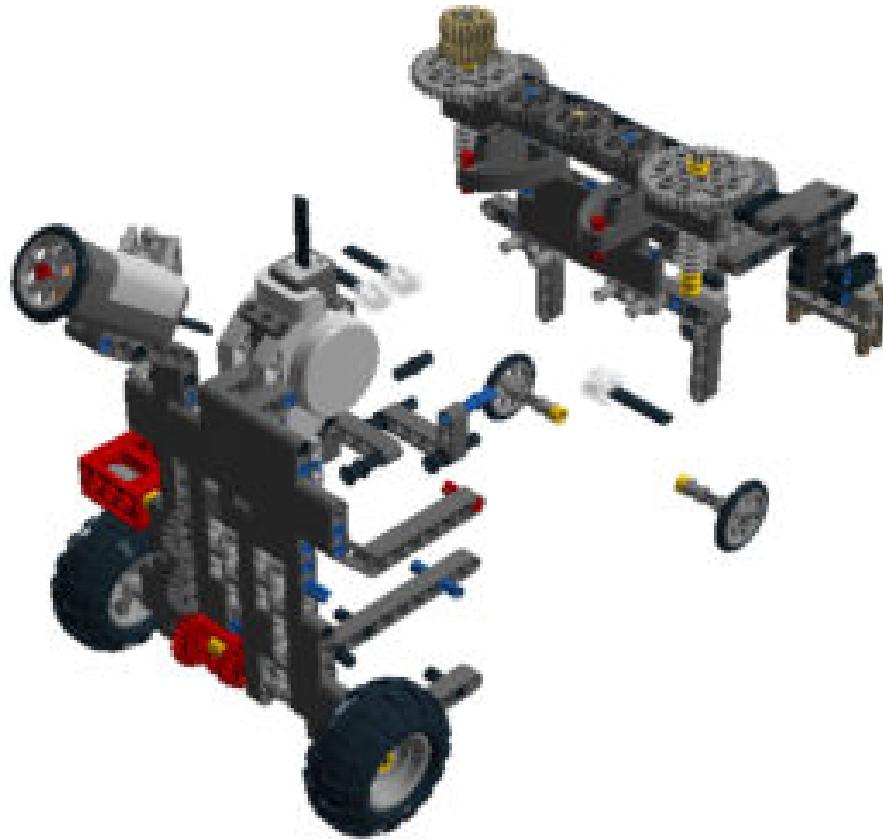
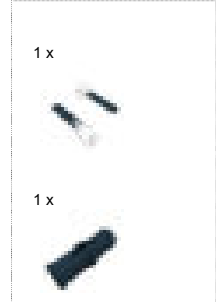

Step 115 of 159

1 x



2 x





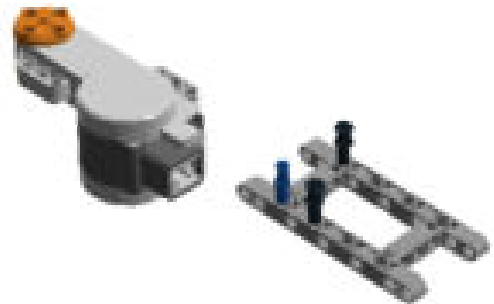
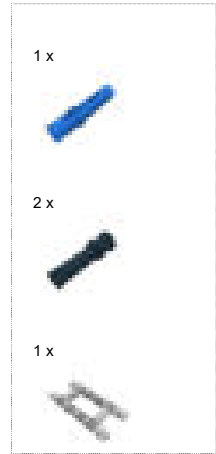

Step 116 of 159

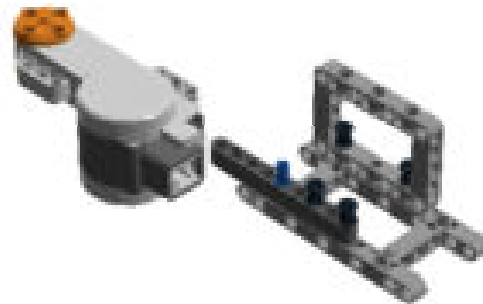
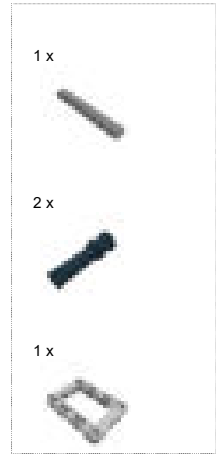

Step 117 of 159



Step 118 of 159

- 1 x 
- 1 x 
- 1 x 
- 1 x 

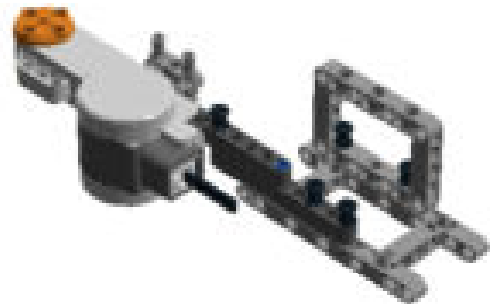

Step 119 of 159

2 x





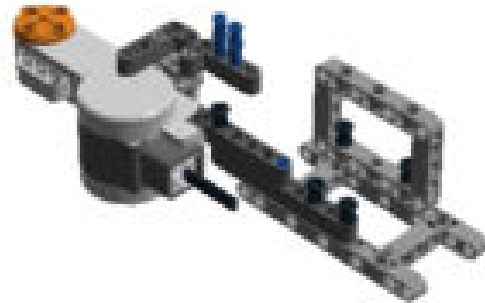

2 x

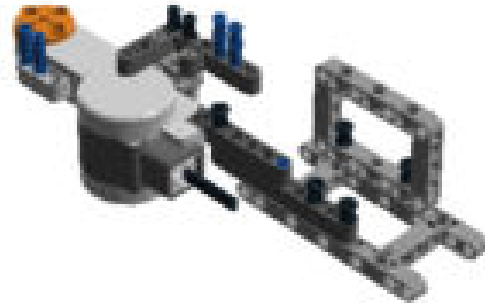
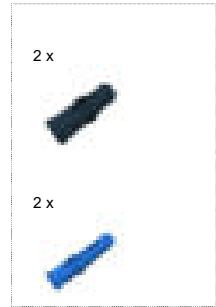

Step 120 of 159





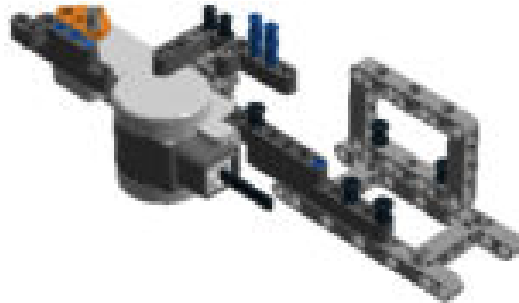

Step 121 of 159

- 1 x 
- 1 x 
- 1 x 
- 1 x 



Step 122 of 159

- 1 x 
- 1 x 
- 1 x 
- 1 x 

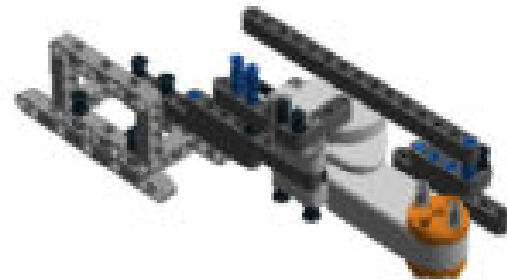

Step 123 of 159

2 x







1 x

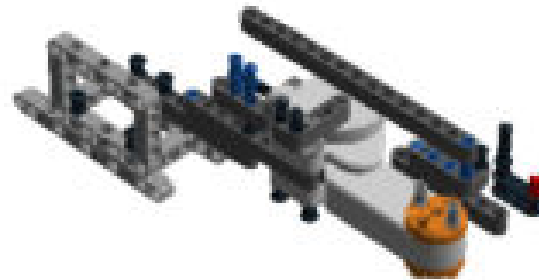

1 x





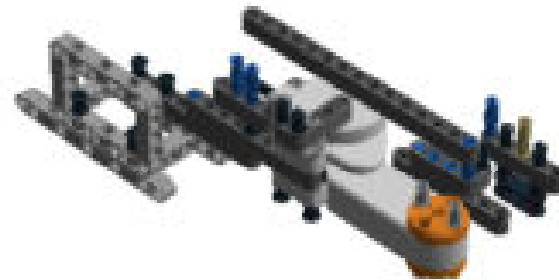

Step 124 of 159

- 1 x 
- 1 x 
- 1 x 
- 1 x 





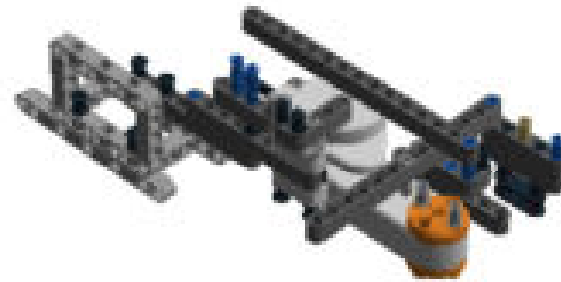

Step 125 of 159

- 1 x 
- 1 x 
- 1 x 
- 1 x 



Step 126 of 159

- 1 x 
- 1 x 
- 1 x 
- 1 x 

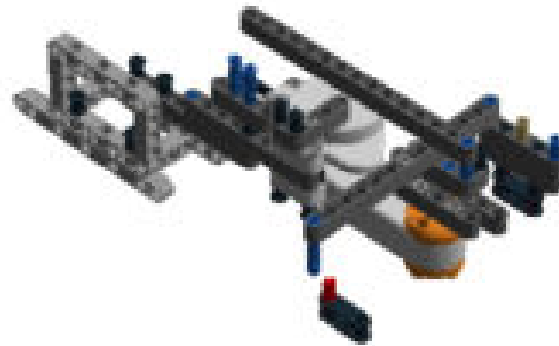

Step 127 of 159

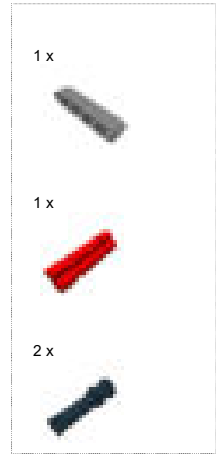

Step 128 of 159

1 x



1 x



1 x



1 x



Step 129 of 159

1 x



1 x



2 x



Step 130 of 159

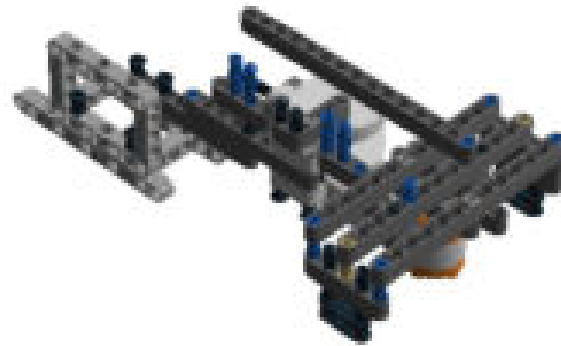
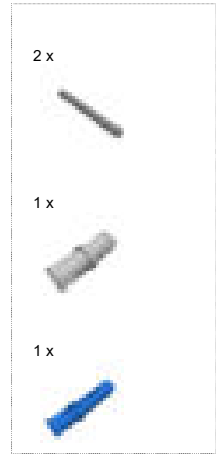

Step 131 of 159

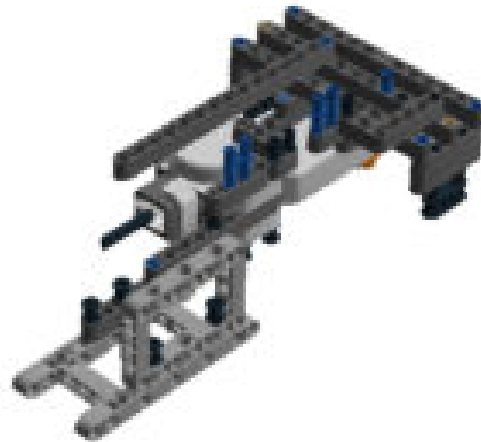
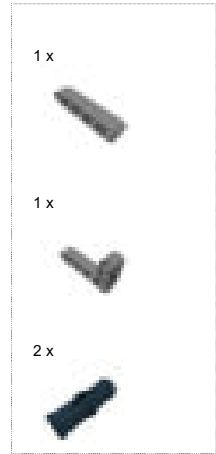

Step 132 of 159

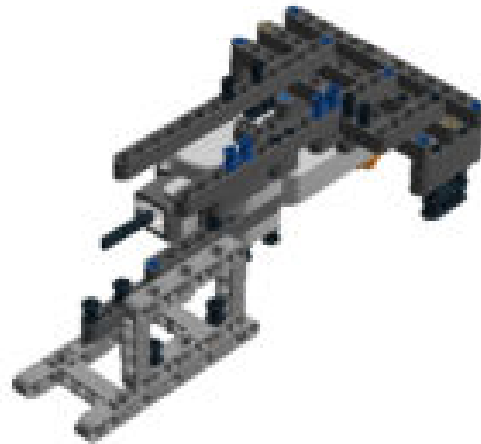
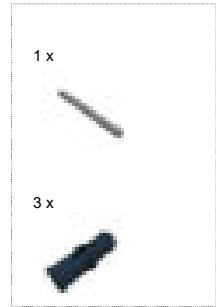

Step 133 of 159

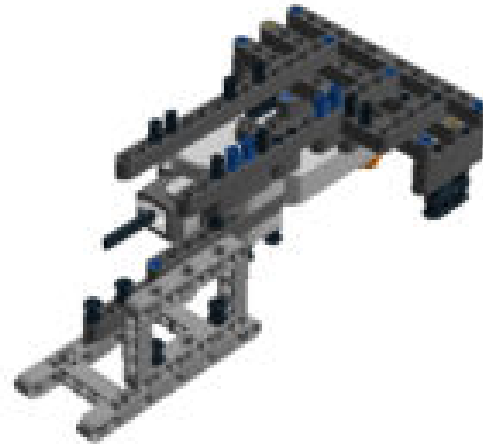
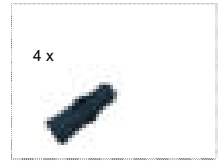

Step 134 of 159

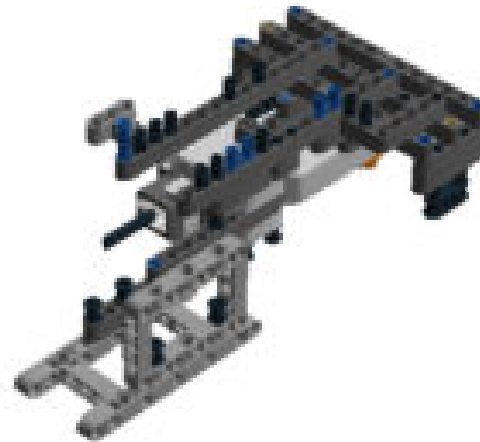
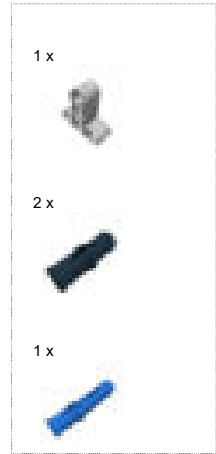

Step 135 of 159





3 x

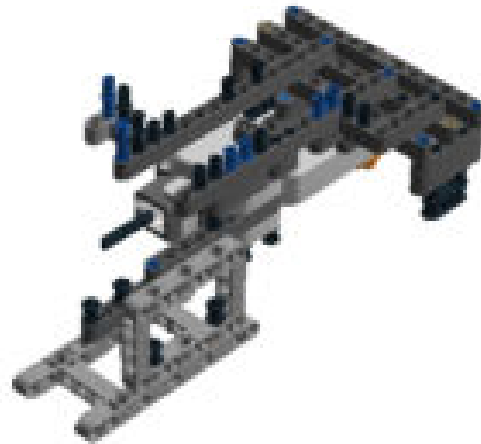

1 x



Step 136 of 159

- 1 x 
- 1 x 
- 1 x 
- 1 x 

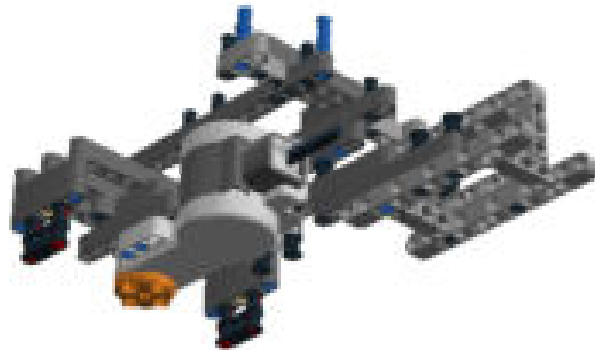

Step 137 of 159

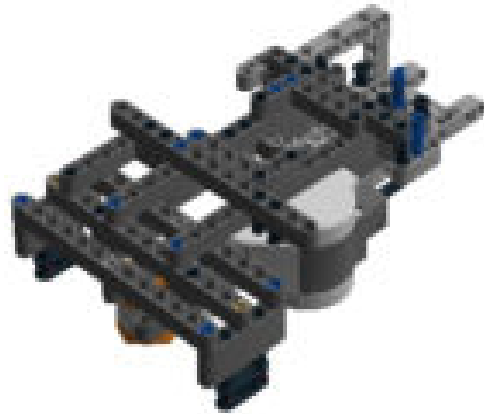
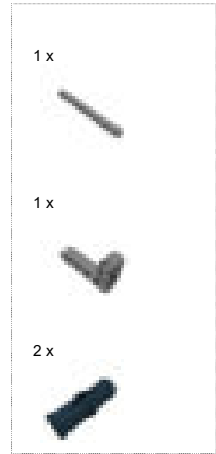

Step 138 of 159

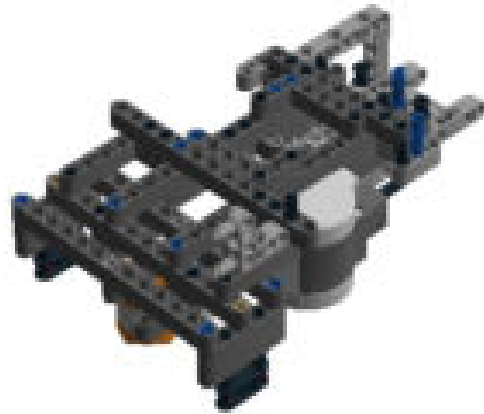
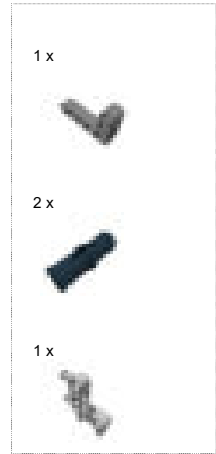

Step 139 of 159

1 x



2 x



1 x

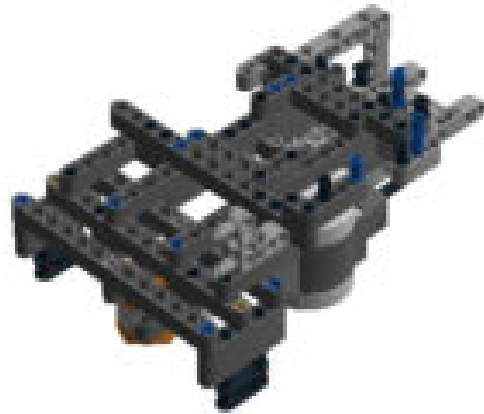

Step 140 of 159

1 x



2 x





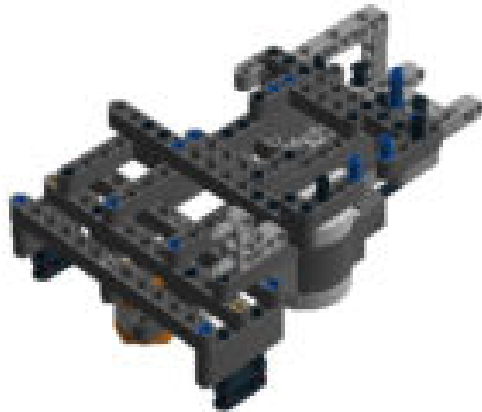

1 x

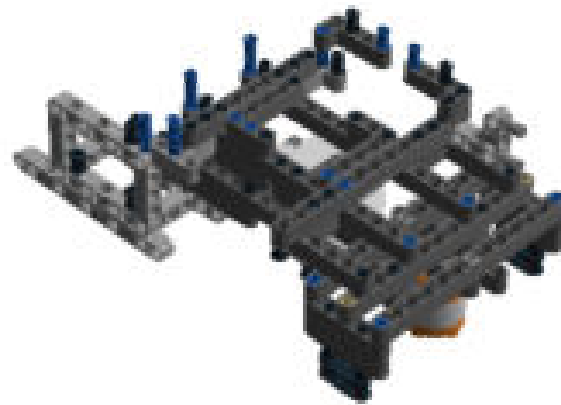
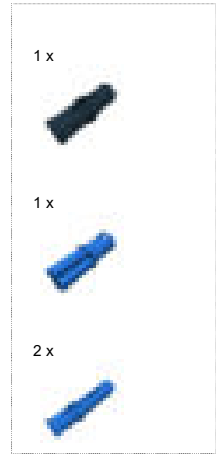

Step 141 of 159





Step 142 of 159

- 1 x 
- 1 x 
- 1 x 
- 1 x 



Step 143 of 159

- 1 x 
- 2 x 
- 1 x 

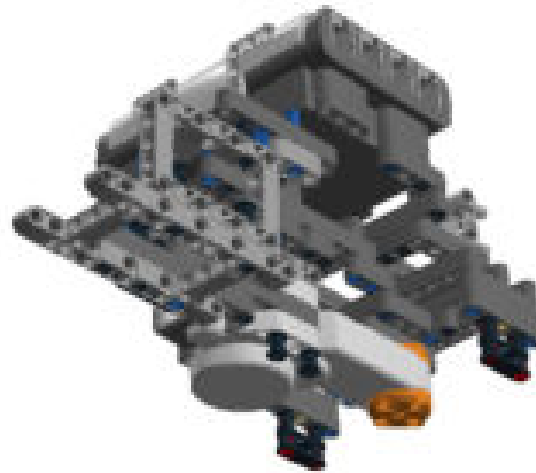

Step 144 of 159

1 x







1 x

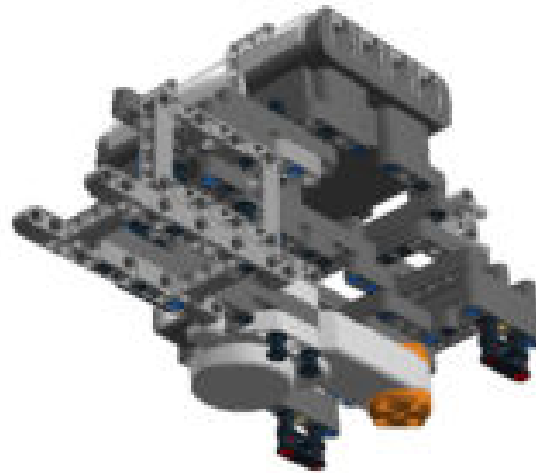
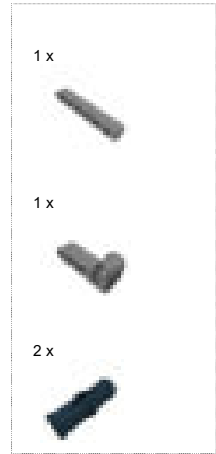

Step 145 of 159



Step 146 of 159

- 1 x 
- 1 x 
- 1 x 
- 1 x 



Step 147 of 159

1 x



1 x







2 x

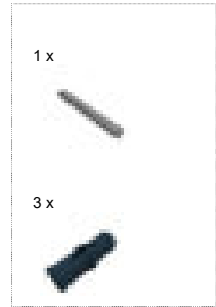

Step 148 of 159



Step 149 of 159

- 1 x 
- 1 x 
- 1 x 
- 1 x 



Step 150 of 159

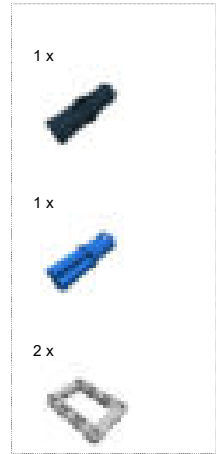

Step 151 of 159

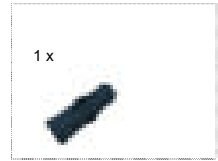

Step 152 of 159

3 x







1 x

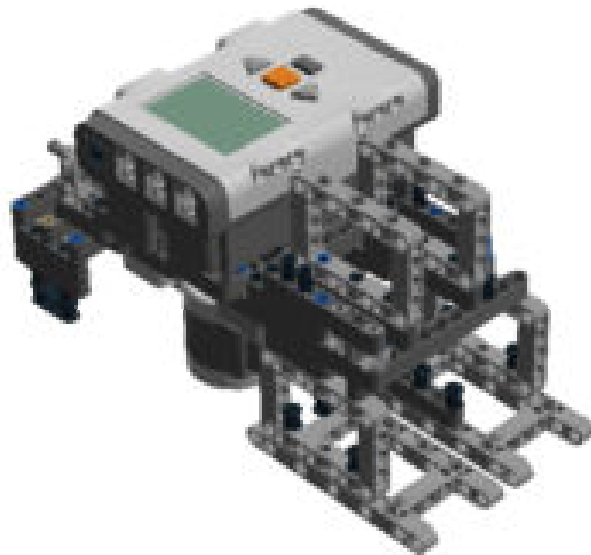
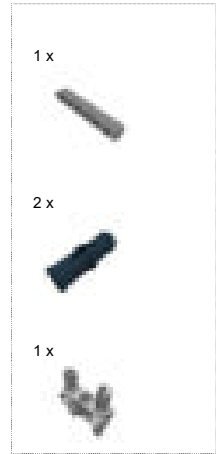

Step 153 of 159



Step 154 of 159

- 1 x 
- 1 x 
- 1 x 
- 1 x 

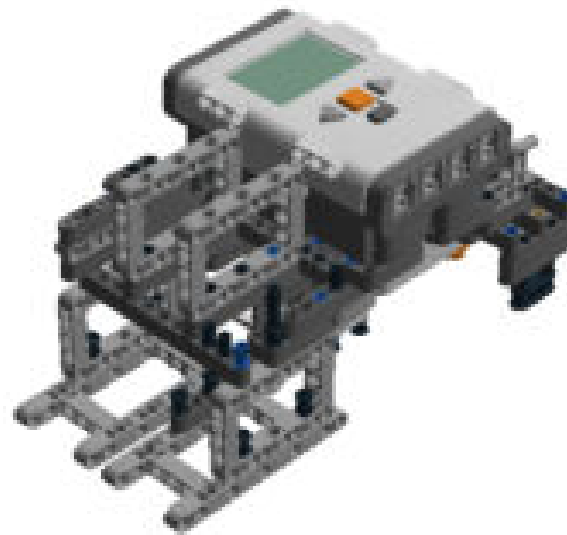

Step 155 of 159

1 x



3 x



Step 156 of 159

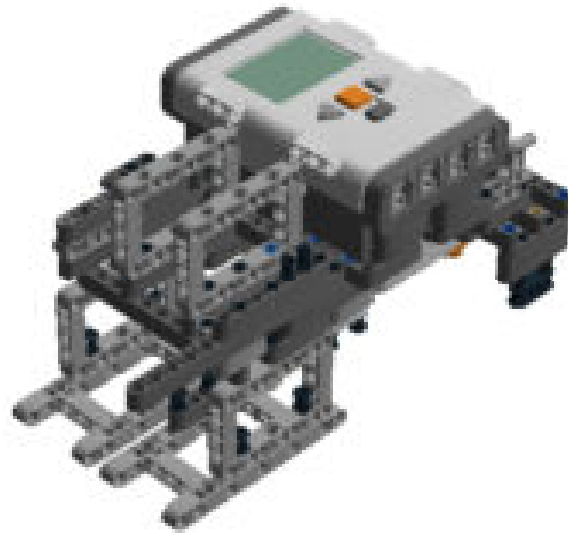
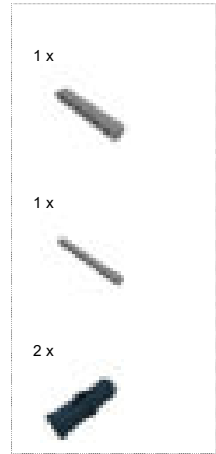

Step 157 of 159

2 x

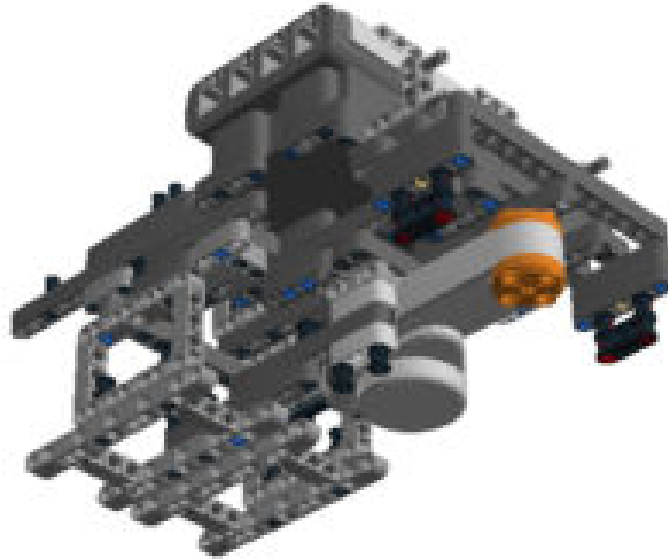

Step 158 of 159

1 x



2 x



Step 159 of 159





- | | | |
|--|---|--|
| 3 x  4210935 BRICK 1X2 WITH CROSS HOLE - Dunkel Steingrau | 1 x  4211441 TECHNIC BRICK 1X4, Ø4,9 - Mittel Steingrau | 2 x  4211445 PLATE 1X4 - Mittel Steingrau |
| 1 x  4211444 PLATE 2X4, 3XØ4.9 - Mittel Steingrau | 3 x  4494222 WEDGE-BELT WHEEL Ø24 - Mittel Steingrau | 3 x  6028041 TYRE FOR WEDGE-BELT WHEEL - Schwarz |
| 2 x  4297210 RIM WIDE W.CROSS 30x20 - Mittel Steingrau | 2 x  4297209 TYRE BALOON WIDE Ø56 X 26 - Schwarz | 6 x  6024583 CABLE 350 MM - Schwarz,Transparent |
| 1 x  4296929 Push sensor - Klares Orange,Mittel Steingrau,Dunkel Steingrau,Helles Steingrau | 2 x  4297008 Tacho Motor - Klares Orange,Dunkel Steingrau,Helles Steingrau | 1 x  6034375 NXT - Schwarz,Klares Orange,Grün Sandfarbe,Mittel Steingrau,Dunkel Steingrau,Helles Steingrau,Cool Silber, |
| 1 x  4211862 TECHNIC 2M BEAM - Mittel Steingrau | 6 x  4210751 TECHNIC 3M BEAM - Dunkel Steingrau | 9 x  4210686 TECHNIC 5M BEAM - Dunkel Steingrau |
| 11 x  4495931 TECHNIC 7M BEAM - Dunkel Steingrau | 10 x  4210667 TECHNIC ANG. BEAM 4X2 90 DEG - Dunkel Steingrau | 6 x  4210757 TECHNIC 9M BEAM - Dunkel Steingrau |
| 6 x  4535772 T-BEAM 3X3 W/HOLE Ø4.8 - Mittel Steingrau | 7 x  4210755 TECHNIC 11M BEAM - Dunkel Steingrau | 7 x  4522937 TECHNIC 13M BEAM - Dunkel Steingrau |
| 5 x  4542576 TECHNIC 15M BEAM - Dunkel Steingrau | 13 x  4210753 TECHNIC ANG. BEAM 3X5 90 DEG. - Dunkel Steingrau | 1 x  4210673 TECHNIC ANGULAR BEAM 3X7 - Dunkel Steingrau |
| 4 x  4210668 DOUBLE ANGULAR BEAM 3X7 45° - Dunkel Steingrau | 4 x  4239896 HALFBEAM CURVE 3X5 - Dunkel Steingrau | 4 x  6009019 TRIANGEL - Mittel Steingrau |

13 x  4239601 1/2 BUSH - Klares Gelb	11 x  4142865 2M CROSS AXLE W. GROOVE - Klares Rot	2 x  4211375 BALL W. CROSS AXLE - Mittel Steingrau
92 x  4121715 CONNECTOR PEG W. FRICTION - Schwarz	4 x  4211807 CONNECTOR PEG - Mittel Steingrau	1 x  4666579 CONNECTOR PEG/CROSS AXLE - Ziegelgelb
12 x  4211622 BUSH FOR CROSS AXLE - Mittel Steingrau	2 x  4184169 BALL WITH FRICTION SNAP - Schwarz	21 x  4206482 CONN.BUSH W.FRIC./CROSSALE - Klares Blau
1 x  370526 CROSS AXLE 4M - Schwarz	4 x  4107083 CROSS AXLE, EXTENSION M/3 RIBS - Schwarz	56 x  4514553 CONNECTOR PEG W. FRICTION 3M - Klares Blau
2 x  4514554 3M CONNECTOR PEG - Ziegelgelb	4 x  6031821 CROSSAXLE 3M WITH KNOB - Gelb Sandfarbe	1 x  4211639 CROSS AXLE 5M - Mittel Steingrau
1 x  4211775 CROSS BLOCK 90° - Mittel Steingrau	3 x  370626 CROSS AXLE 6M - Schwarz	2 x  6083620 CROSS AXLE 4M WITH END STOP - Dunkel Steingrau
21 x  4107742 2M FRIC. SNAP W/CROSS HOLE - Schwarz	3 x  4211805 CROSS AXLE 7M - Mittel Steingrau	2 x  4121667 DOUBLE CROSS BLOCK - Schwarz
3 x  370726 CROSS AXLE 8M - Schwarz	1 x  4107783 ANGLE ELEMENT, 180 DEGREES [2] - Schwarz	3 x  4210857 CROSS BLOCK 3M - Dunkel Steingrau
1 x  4535768 CROSS AXLE 9M - Mittel Steingrau	2 x  373726 CROSS AXLE 10M - Schwarz	2 x  4210655 TECHNIC CROSS BLOCK 2X1 - Dunkel Steingrau

2 x  4234599 **TECHNIC CROSS BLOCK/FORK 2X2** - Dunkel Steingrau

2 x  4119589 **MODULE BUSH** - Schwarz

2 x  4143466 **TECHNIC CROSSBLOCK 2X3** - Schwarz

1 x  4502595 **3-BRANCH CROSS AXLE W/CROSS H.** - Mittel Steingrau

10 x  4225033 **BEAM 3 M. W/4 SNAPS** - Mittel Steingrau

4 x  4296059 **Angular beam 90degr. w.4 snaps** - Mittel Steingrau

4 x  4539880 **BEAM FRAME 5X7 Ø 4.85** - Mittel Steingrau

2 x  4540797 **BEAM H. FRAME 5X11 Ø4.85** - Mittel Steingrau

3 x  4142298 **CONICAL WHEEL Z12** - Klares Rot

3 x  4211510 **WORM** - Mittel Steingrau

2 x  4514555 **DOUBLE CONICAL WHEEL Z20 1M** - Ziegelgelb

7 x  4514558 **GEAR WHEEL Z24** - Dunkel Steingrau

4 x  4285634 **GEAR WHEEL 40T** - Mittel Steingrau

1 x  4106381 **WORM GEAR BLOCK, TRANSP.** - Klares Rot

1 x  657321 **DIFFERENTIALE GEAR CASING** - Klares Rot

© 2012 The LEGO Group. All rights reserved.
Use of the LEGO Digital Designer html print tool, signifies your agreement to the terms of use.