

LEGO DIGITAL DESIGNER 4.2

Model Name:
Modell

Number of Bricks: 286

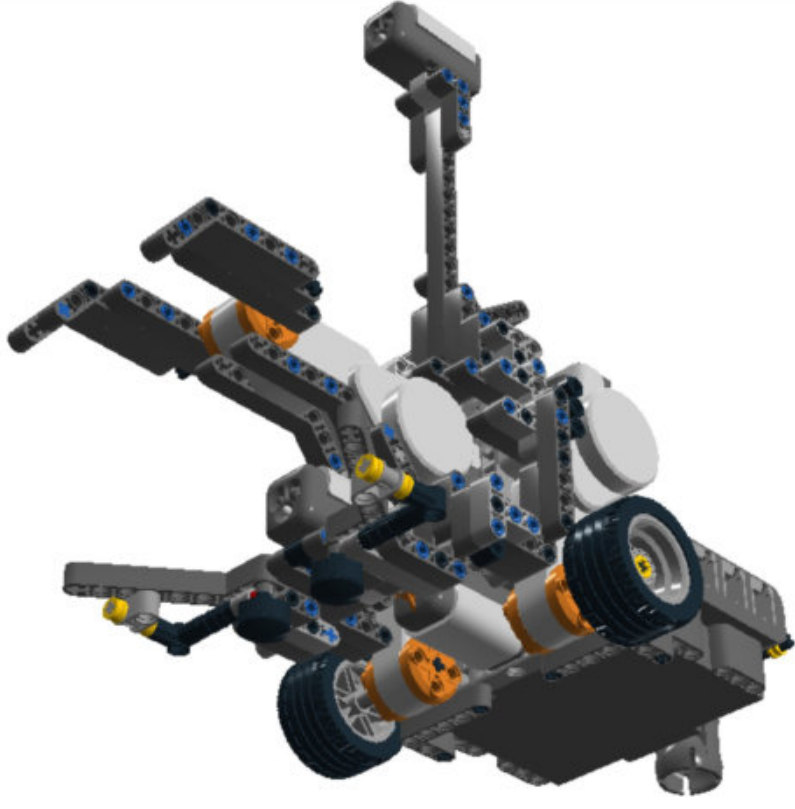

Step 1 of 116

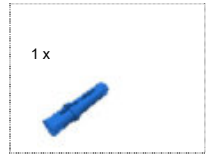

Step 2 of 116



Step 3 of 116

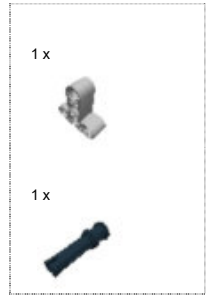

Step 4 of 116



Step 5 of 116

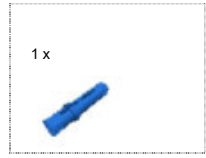

Step 6 of 116



Step 7 of 116

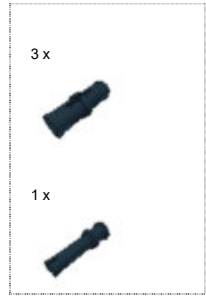



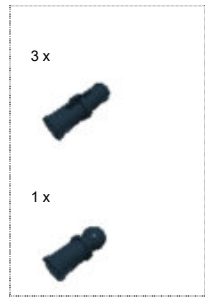

Step 8 of 116

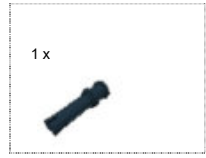

Step 9 of 116





Step 10 of 116

- 1 x 
- 1 x 
- 1 x 
- 1 x 



Step 11 of 116

- 1 x 
- 1 x 
- 1 x 



Step 12 of 116



Step 13 of 116

1 x



1 x



1 x



1 x



Step 14 of 116

1 x



1 x



1 x



1 x



Step 15 of 116

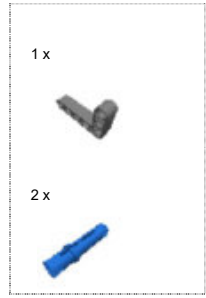

Step 16 of 116

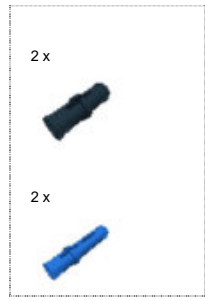

Step 17 of 116

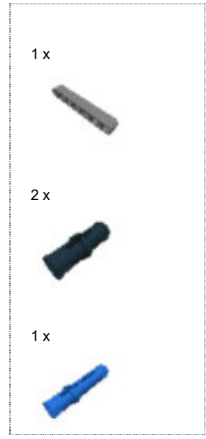

Step 18 of 116



Step 19 of 116



Step 20 of 116

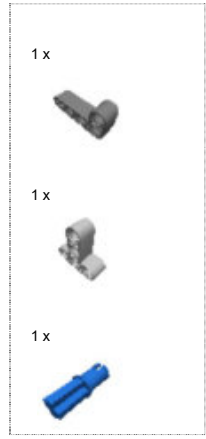

Step 21 of 116

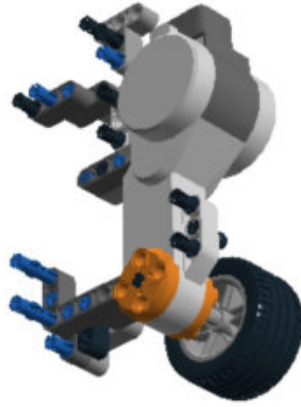

Step 22 of 116

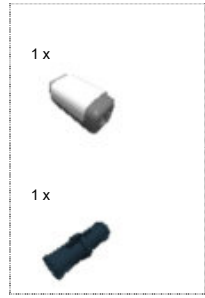

Step 23 of 116

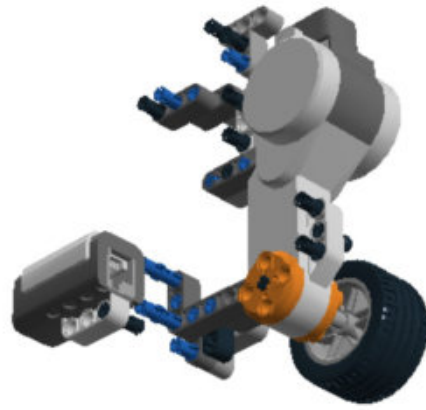

Step 24 of 116

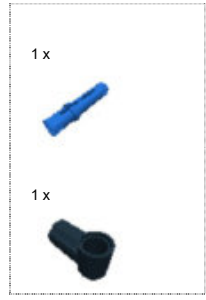

Step 25 of 116



Step 26 of 116

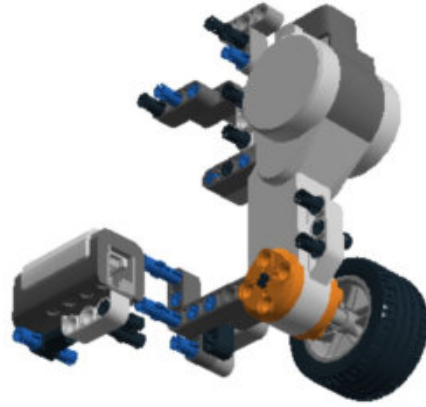

Step 27 of 116

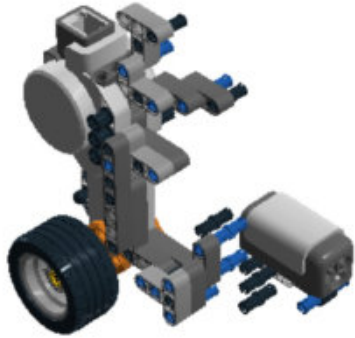

Step 28 of 116

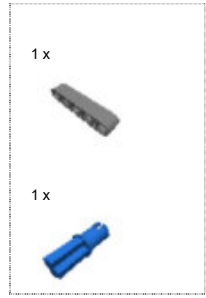

Step 29 of 116

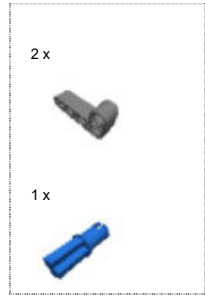

Step 30 of 116

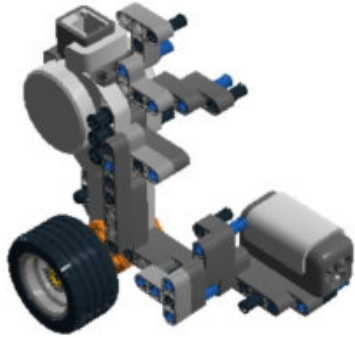

Step 31 of 116

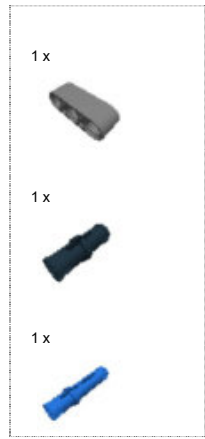

Step 32 of 116

1 x



2 x



1 x



Step 33 of 116



Step 34 of 116

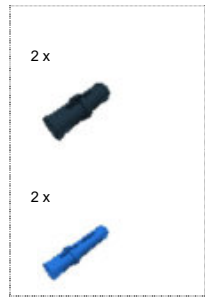

Step 35 of 116

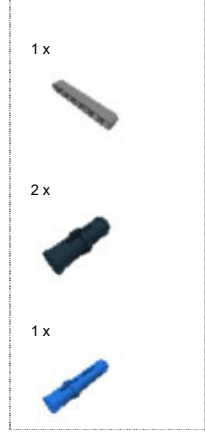

Step 36 of 116

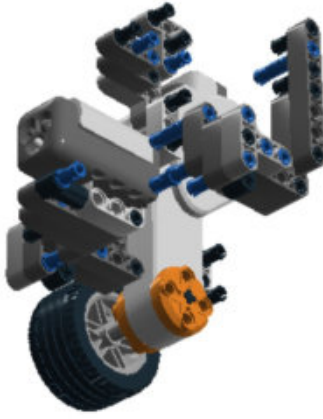

Step 37 of 116

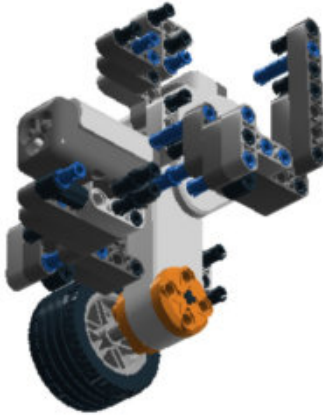

Step 38 of 116

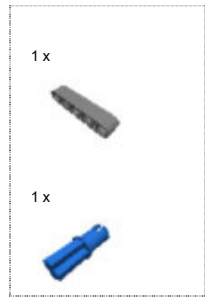

Step 39 of 116

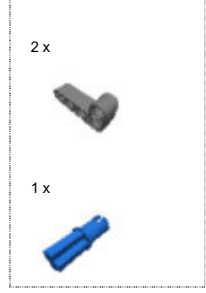

Step 40 of 116

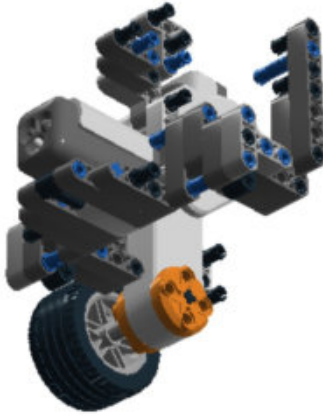

Step 41 of 116

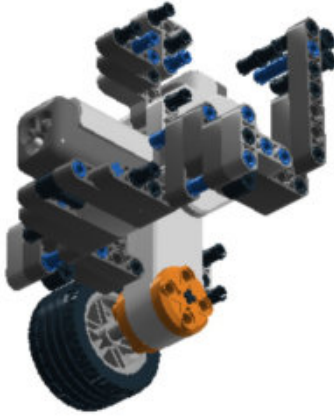
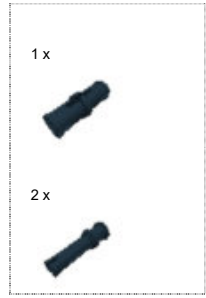

Step 42 of 116

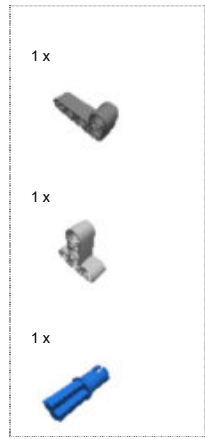

Step 43 of 116



Step 44 of 116

1 x



1 x



1 x



1 x



Step 45 of 116

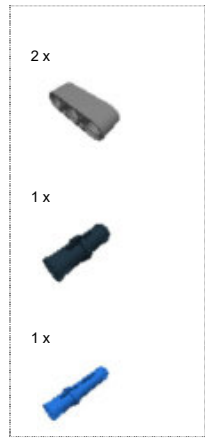

Step 46 of 116

1 x



2 x



1 x



Step 47 of 116







Step 48 of 116

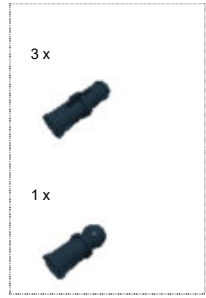

Step 49 of 116



Step 50 of 116

- 1 x 
- 1 x 
- 1 x 
- 1 x 



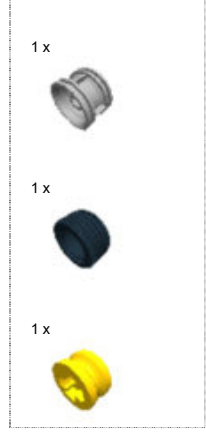

Step 51 of 116

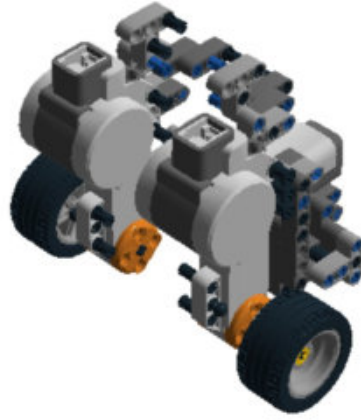

Step 52 of 116



Step 53 of 116

- 1 x 
- 1 x 
- 1 x 



Step 54 of 116

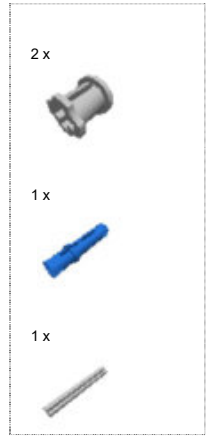

Step 55 of 116

2 x



2 x



Step 56 of 116

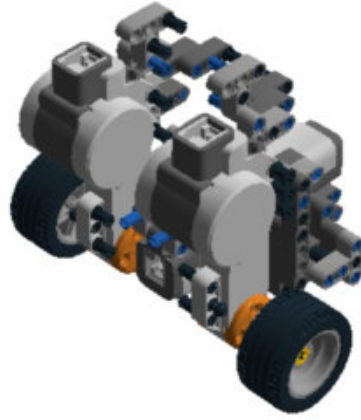

Step 57 of 116

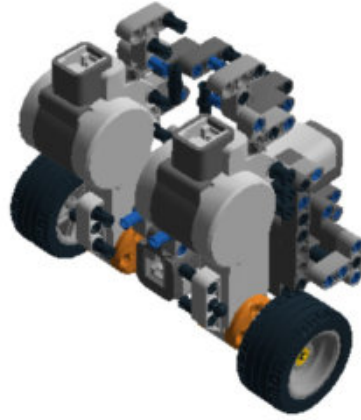

Step 58 of 116

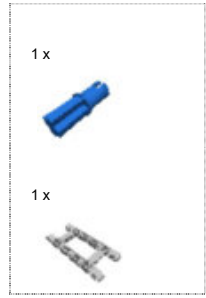

Step 59 of 116

1 x



2 x





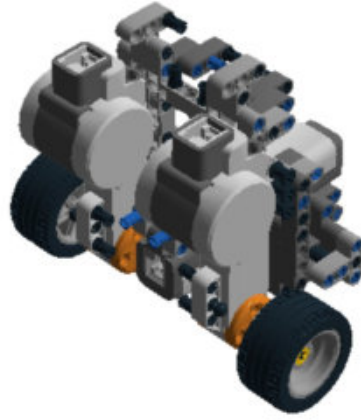

Step 60 of 116

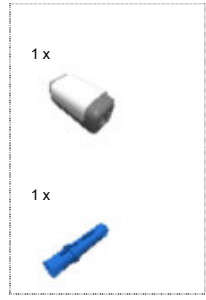

Step 61 of 116



Step 62 of 116

- 1 x 
- 1 x 
- 1 x 
- 1 x 



Step 63 of 116

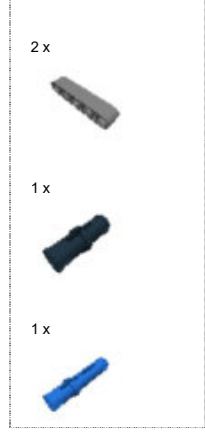

Step 64 of 116

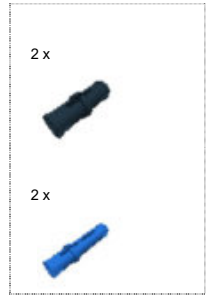

Step 65 of 116

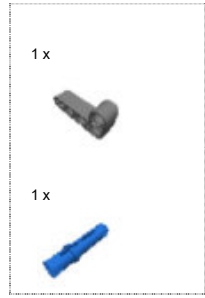

Step 66 of 116

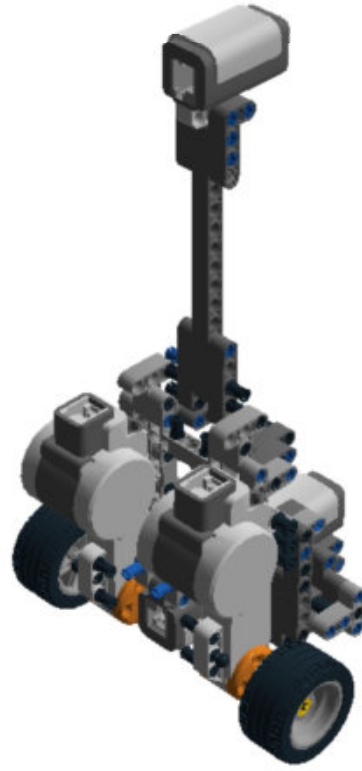

Step 67 of 116

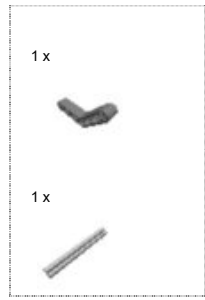

Step 68 of 116

1 x



2 x



1 x





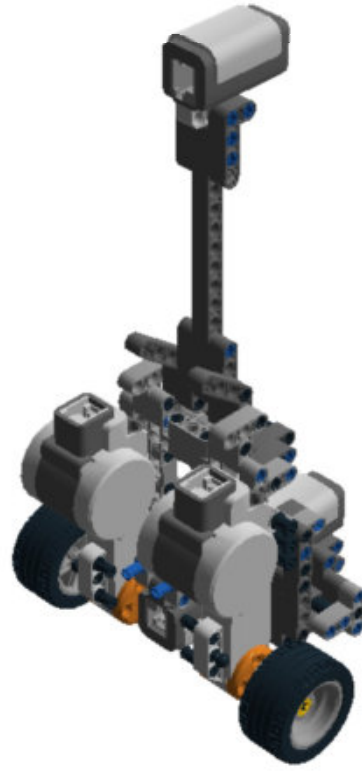

Step 69 of 116

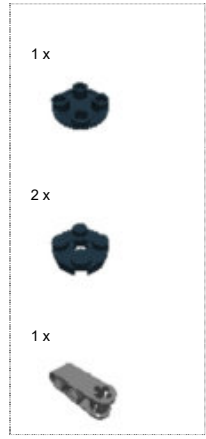

Step 70 of 116



Step 71 of 116

- 1 x 
- 1 x 
- 1 x 
- 1 x 



Step 72 of 116

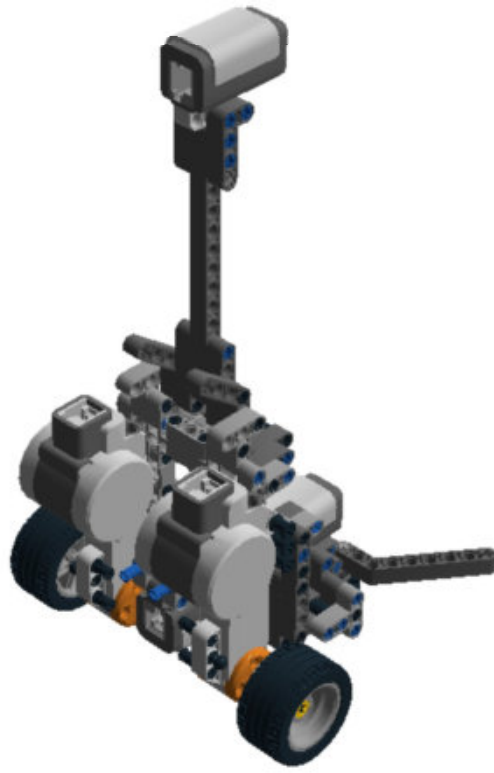

Step 73 of 116



Step 74 of 116

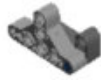
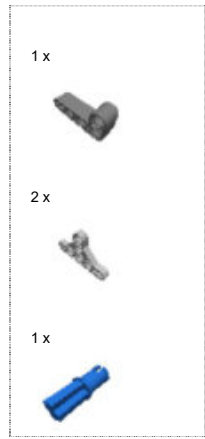

Step 75 of 116

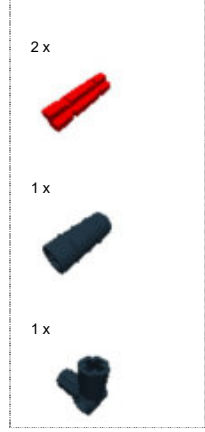

Step 76 of 116

2 x



1 x



1 x







Step 77 of 116

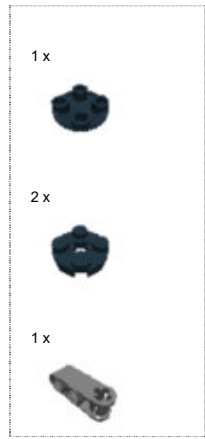

Step 78 of 116



Step 79 of 116

- 1 x 
- 1 x 
- 1 x 
- 1 x 



Step 80 of 116



Step 81 of 116



Step 82 of 116

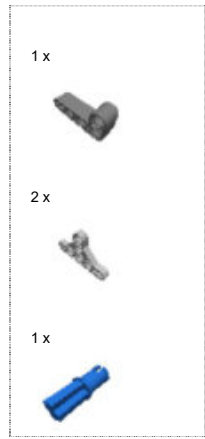

Step 83 of 116

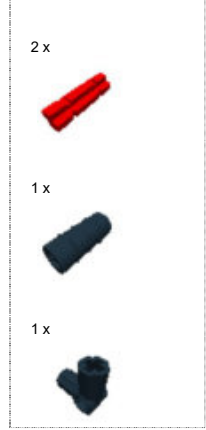

Step 84 of 116

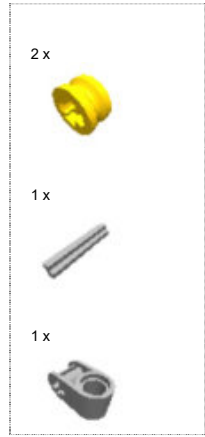

Step 85 of 116

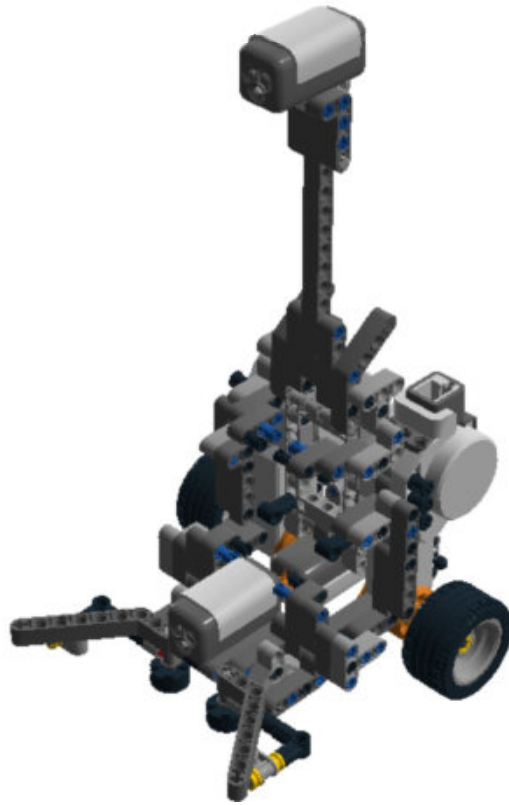

Step 86 of 116

1 x



1 x

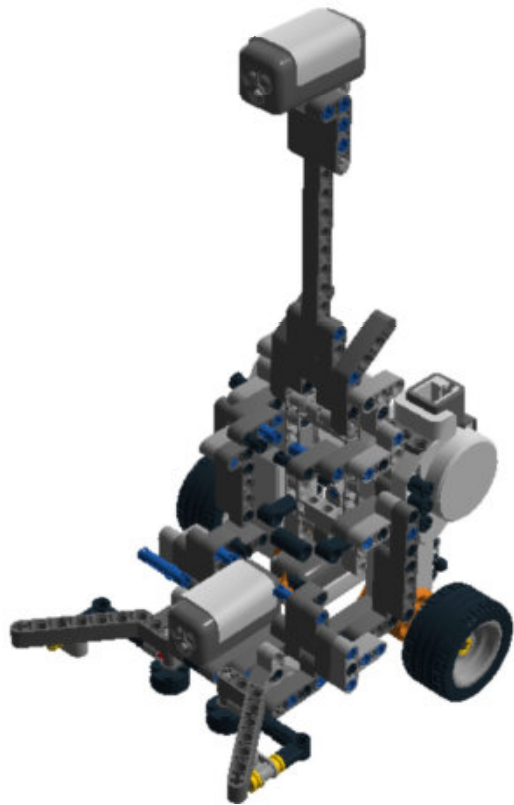

Step 87 of 116

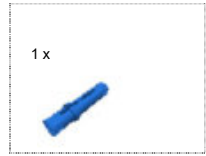

Step 88 of 116



Step 89 of 116

1 x



1 x



1 x



1 x



Step 90 of 116

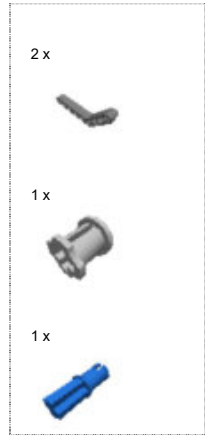

Step 91 of 116

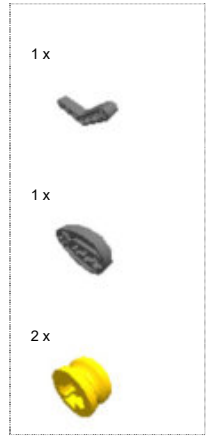

Step 92 of 116



Step 93 of 116



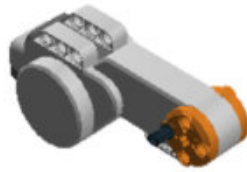
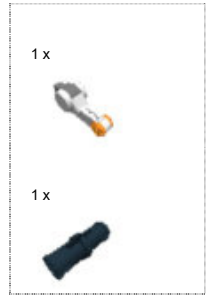

Step 94 of 116

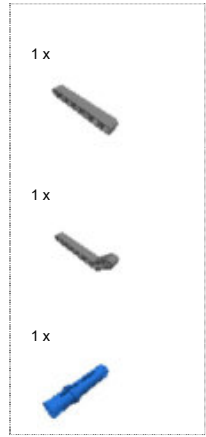

Step 95 of 116



Step 96 of 116

- 1 x 
- 1 x 
- 2 x 



Step 97 of 116

1 x



1 x





1 x



1 x



Step 98 of 116

- 1 x 
- 1 x 
- 2 x 

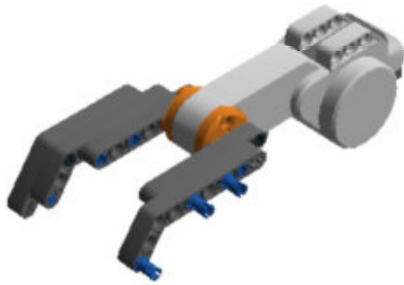

Step 99 of 116

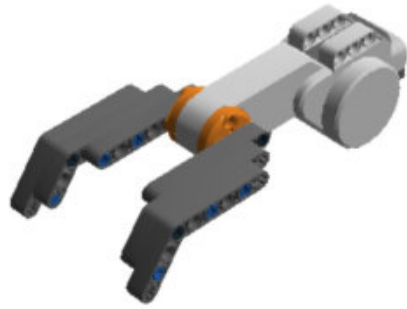

Step 100 of 116

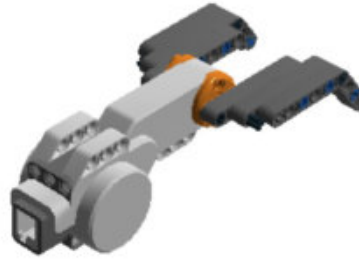

Step 101 of 116



Step 102 of 116

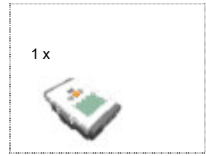

Step 103 of 116

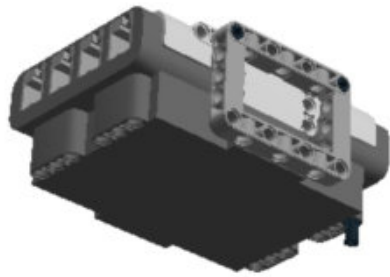
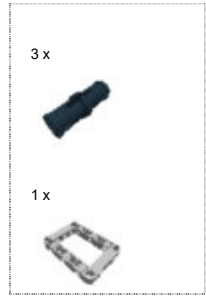

Step 104 of 116

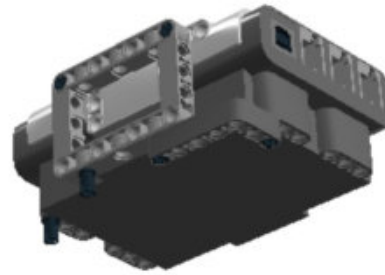
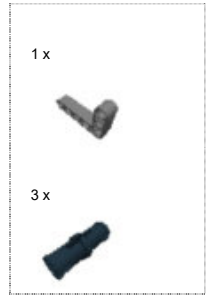

Step 105 of 116

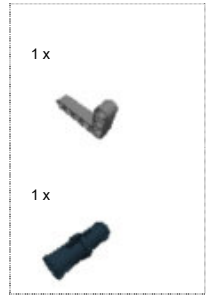

Step 106 of 116

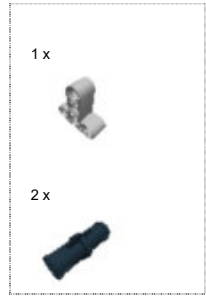

Step 107 of 116

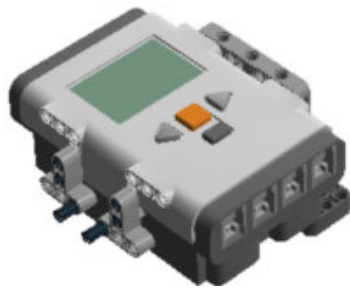
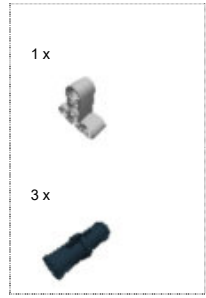

Step 108 of 116

- 1 x 
- 2 x 
- 1 x 

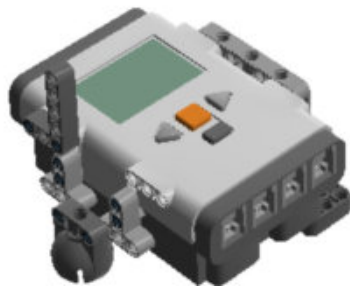

Step 109 of 116

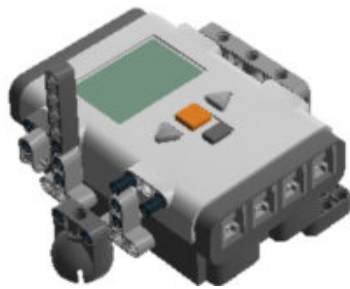

Step 110 of 116

- 1 x 
- 1 x 
- 1 x 

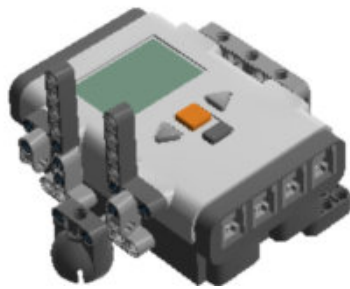



Step 111 of 116

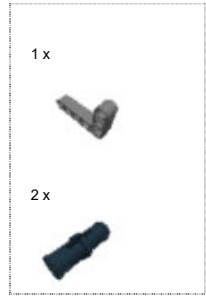

Step 112 of 116



Step 113 of 116



- 1 x 
- 2 x 
- 1 x 

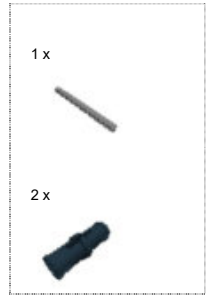

Step 114 of 116







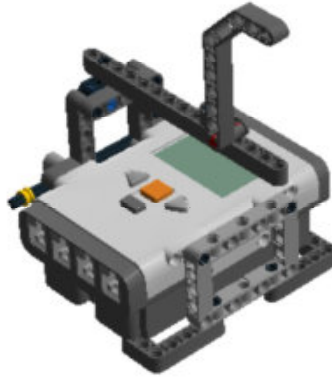



































Step 115 of 116

- 1 x 
- 1 x 
- 1 x 



Step 116 of 116



2 x		4278359	SLIDE SHOE ROUND 2X2 - Schwarz	4 x		403226	PLATE 2X2 ROUND - Schwarz	2 x		4297210	RIM WIDE W.CROSS 30x20 - Mittel Steingrau
2 x		4184286	TYRE NORMAL WIDE Ø43,2 X 22 - Schwarz	2 x		4546542	COLOUR SENSOR, ASSEMBLED - Mittel Steingrau, Dunkel Steingrau, Helles Steingrau	1 x		4296929	Push sensor - Klares Orange, Mittel Steingrau, Dunkel Steingrau, Helles Steingrau
3 x		4297008	Tacho Motor - Klares Orange, Dunkel Steingrau, Helles Steingrau	1 x		6034375	NXT - Schwarz, Klares Orange, Grün Sandfarbe, Mittel Steingrau, Dunkel Steingrau, Helles Steingrau, Cool Silber,	6 x		4210751	TECHNIC 3M BEAM - Dunkel Steingrau
4 x		4495931	TECHNIC 7M BEAM - Dunkel Steingrau	10 x		4210667	TECHNIC ANG. BEAM 4X2 90 DEG - Dunkel Steingrau	4 x		4210686	TECHNIC 5M BEAM - Dunkel Steingrau
2 x		4542576	TECHNIC 15M BEAM - Dunkel Steingrau	9 x		4210753	TECHNIC ANG. BEAM 3X5 90 DEG. - Dunkel Steingrau	10 x		4535772	T-BEAM 3X3 W/HOLE Ø4.8 - Mittel Steingrau
4 x		4210673	TECHNIC ANGULAR BEAM 3X7 - Dunkel Steingrau	4 x		4210638	TECHNIC ANGULAR BEAM 4X6 - Dunkel Steingrau	4 x		4210656	TECHNIC ANGULAR BEAM 4X4 - Dunkel Steingrau
2 x		4210759	COMB WHEEL - Dunkel Steingrau	4 x		6009019	TRIANGEL - Mittel Steingrau	1 x		4210668	DOUBLE ANGULAR BEAM 3X7 45° - Dunkel Steingrau
6 x		4142865	2M CROSS AXLE W. GROOVE - Klares Rot	74 x		4121715	CONNECTOR PEG W. FRICTION - Schwarz	14 x		4239601	1/2 BUSH - Klares Gelb
9 x		4211622	BUSH FOR CROSS AXLE - Mittel Steingrau	2 x		4184169	BALL WITH FRICTION SNAP - Schwarz	5 x		4211815	CROSS AXLE 3M - Mittel Steingrau
2 x		4107083	CROSS AXLE. EXTENSION M/3 RIBS - Schwarz	38 x		4514553	CONNECTOR PEG W. FRICTION 3M - Klares Blau	18 x		4206482	CONN.BUSH W.FRIC./CROSSALE - Klares Blau
6 x		4211775	CROSS BLOCK 90° - Mittel Steingrau	3 x		4107085	ANGLE ELEMENT, 0 DEGREES [1] - Schwarz	3 x		4211639	CROSS AXLE 5M - Mittel Steingrau
1 x		4526982	TUBE Ø7,84 2M - Schwarz	3 x		370626	CROSS AXLE 6M - Schwarz	2 x		6006140	BEAM 1X2 W/CROSS AND HOLE - Schwarz
1 x		4121667	DOUBLE CROSS BLOCK - Schwarz	2 x		370726	CROSS AXLE 8M - Schwarz	6 x		4107742	2M FRIC. SNAP W/CROSS HOLE - Schwarz
								3 x		4210857	CROSS BLOCK 3M - Dunkel Steingrau

2 x  4107767 ANGLE ELEMENT, 90 DEGREES [6] - Schwarz

1 x  370826 CROSS AXLE 12M - Schwarz

1 x  4538007 CROSS BLOCK 3X2 - Mittel Steingrau

1 x  4610380 POWER JOINT - Dunkel Steingrau

1 x  4539880 BEAM FRAME 5X7 Ø 4.85 - Mittel Steingrau

1 x  4540797 BEAM H. FRAME 5X11 Ø4.85 - Mittel Steingrau

© 2012 The LEGO Group. All rights reserved.
Use of the LEGO Digital Designer html print tool, signifies your agreement to the terms of use.