

LEGO DIGITAL DESIGNER 4.2

Model Name:
Bauplan Lego

Number of Bricks: 422

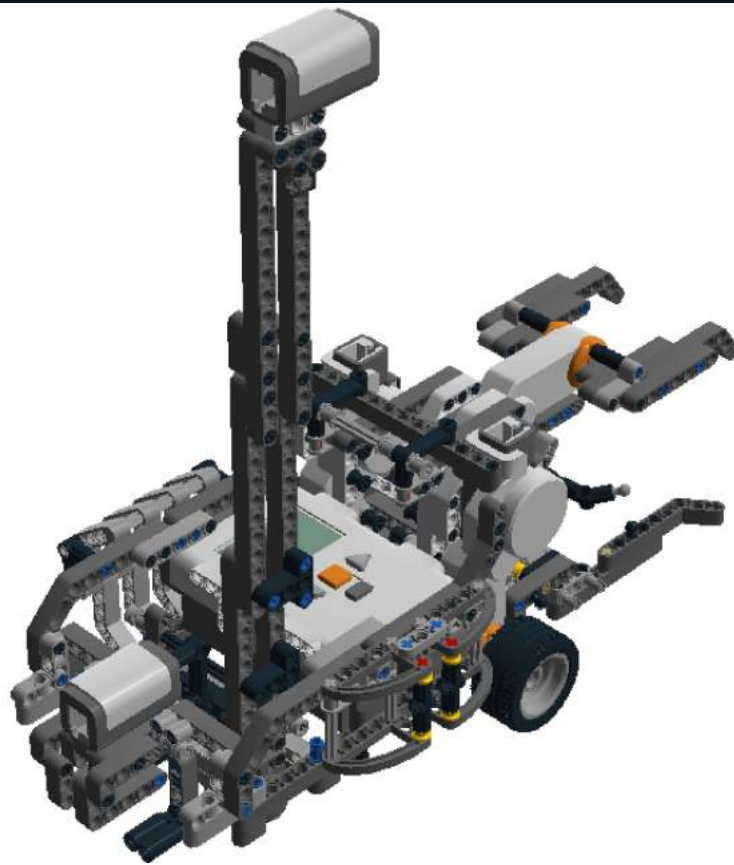

Step 1 of 198



Step 2 of 198



Step 3 of 198



Step 4 of 198



Step 5 of 198



Step 6 of 198



Step 7 of 198



Step 8 of 198

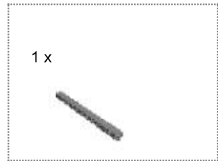

Step 9 of 198



Step 10 of 198



Step 11 of 198

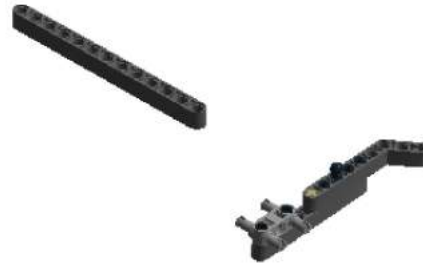
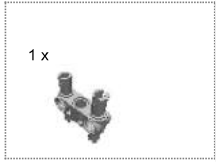

Step 12 of 198

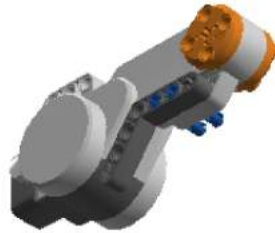

Step 13 of 198

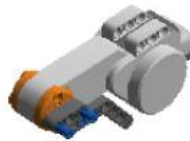
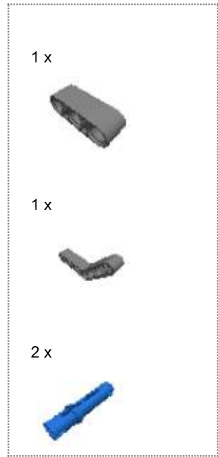

Step 14 of 198



Step 15 of 198

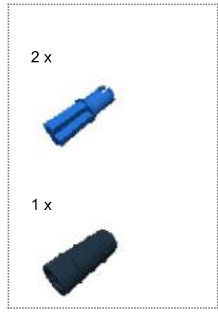

Step 16 of 198



Step 17 of 198

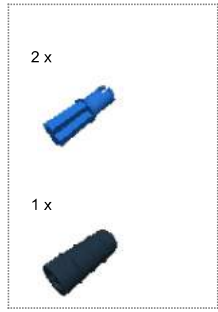

Step 18 of 198



Step 19 of 198



Step 20 of 198

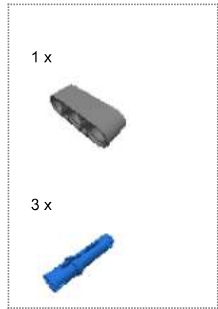

Step 21 of 198

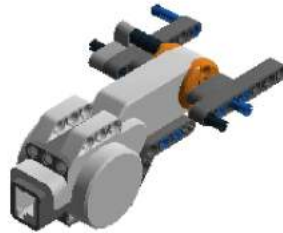
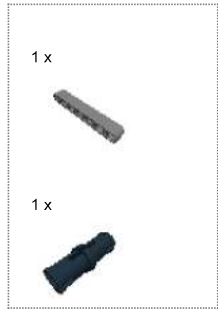

Step 22 of 198

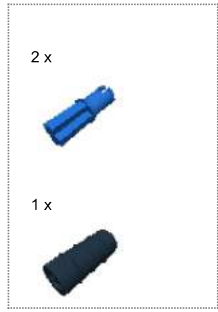

Step 23 of 198

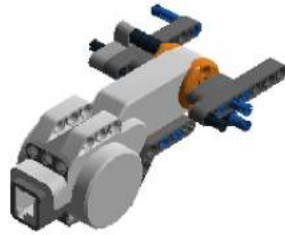

Step 24 of 198

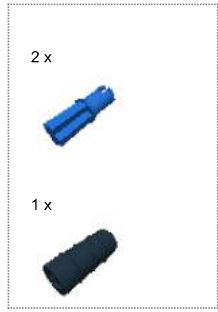

Step 25 of 198

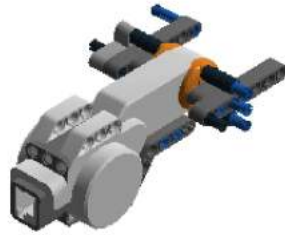

Step 26 of 198

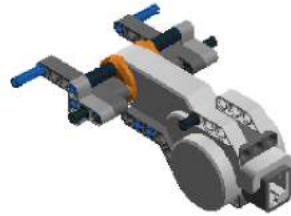

Step 27 of 198

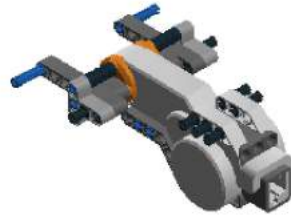

Step 28 of 198

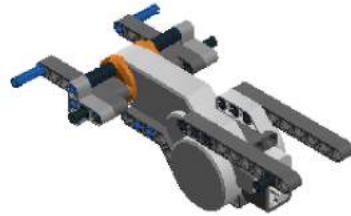
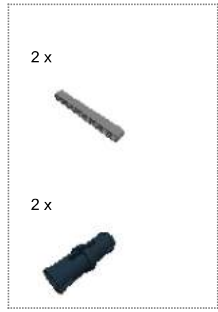

Step 29 of 198

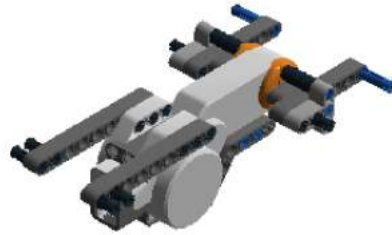

Step 30 of 198

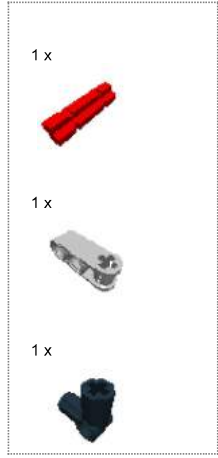

Step 31 of 198

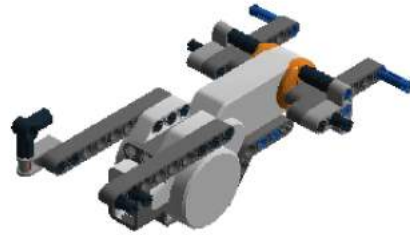

Step 32 of 198

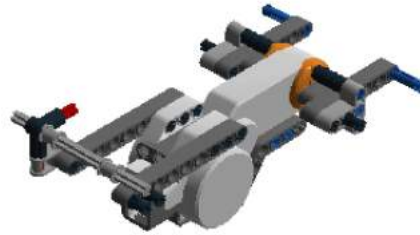

Step 33 of 198

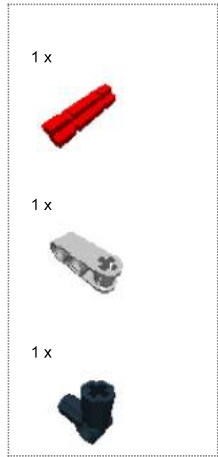

Step 34 of 198

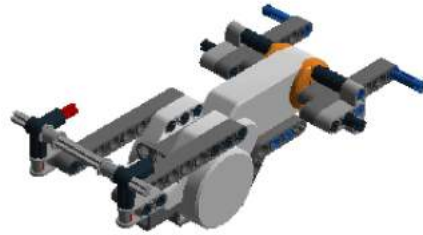

Step 35 of 198

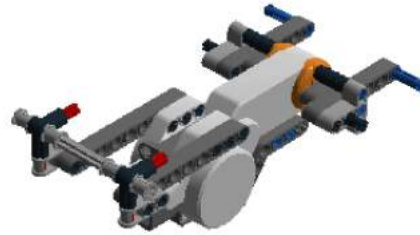
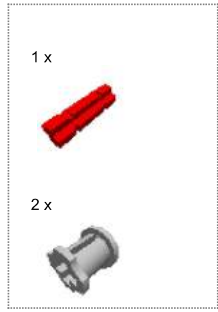

Step 36 of 198

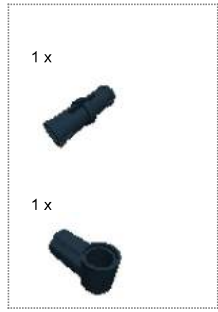

Step 37 of 198

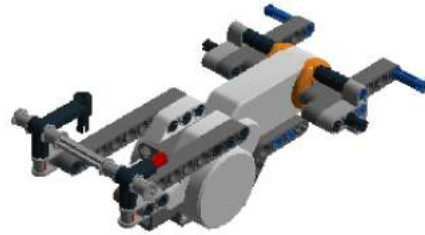

Step 38 of 198

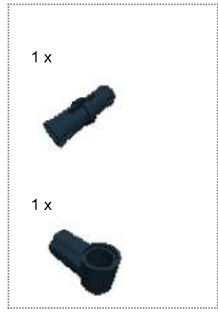

Step 39 of 198

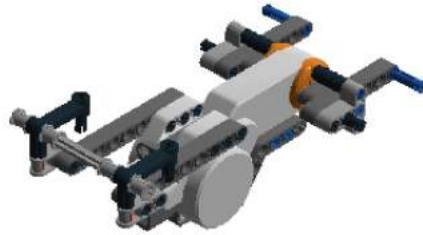

Step 40 of 198

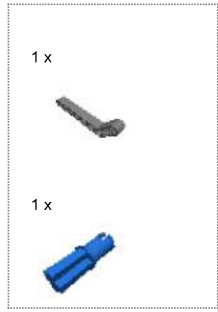

Step 41 of 198

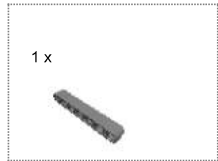

Step 42 of 198

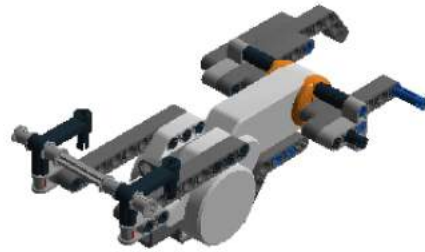

Step 43 of 198

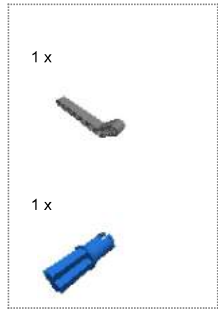

Step 44 of 198

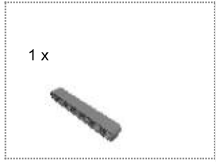

Step 45 of 198

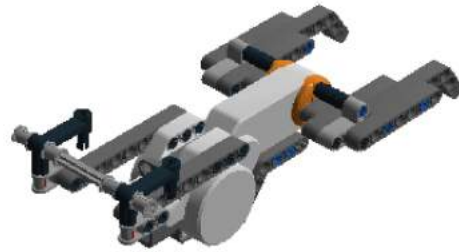

Step 46 of 198

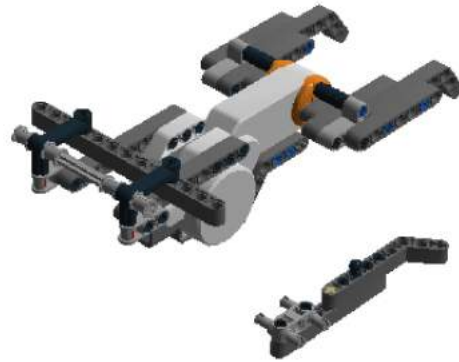

Step 47 of 198



Step 48 of 198



Step 49 of 198

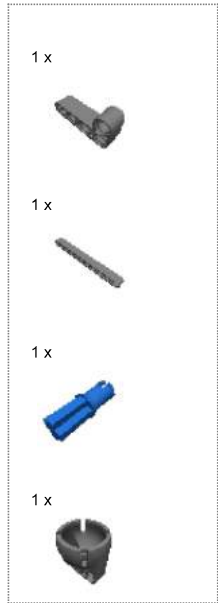

Step 50 of 198

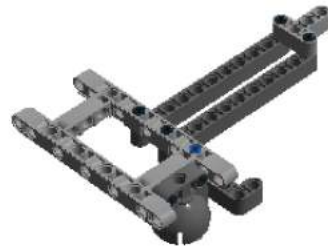
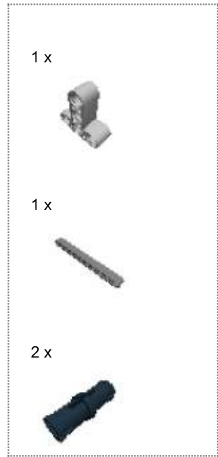

Step 51 of 198

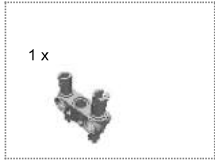

Step 52 of 198



Step 53 of 198



Step 54 of 198

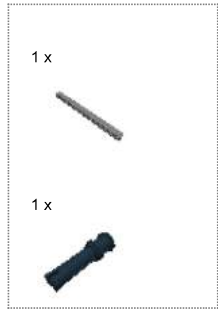

Step 55 of 198

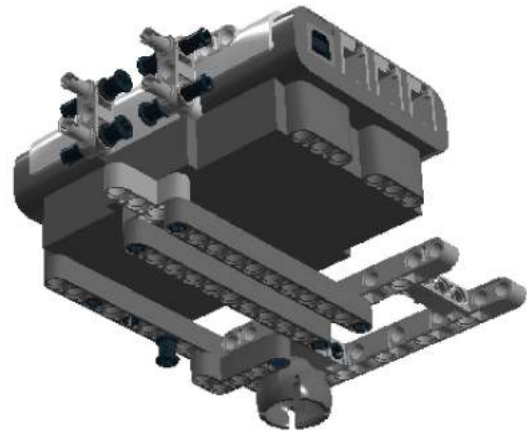

Step 56 of 198

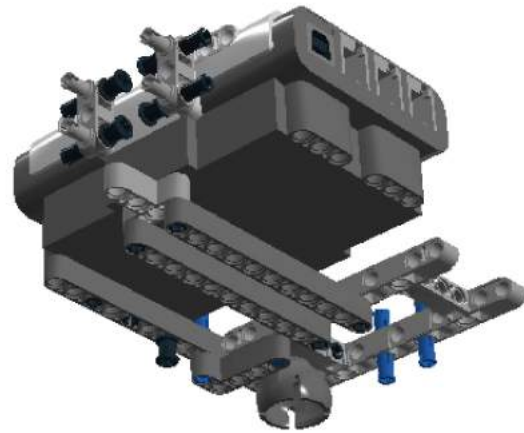

Step 57 of 198

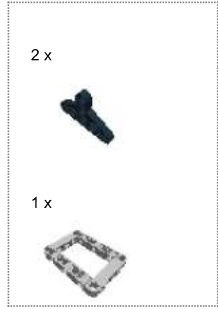

Step 58 of 198



Step 59 of 198



Step 60 of 198

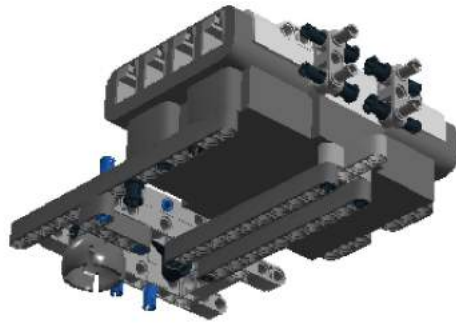

Step 61 of 198

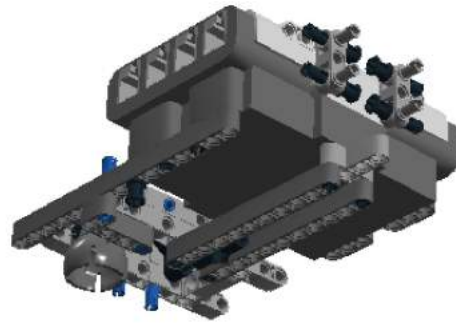

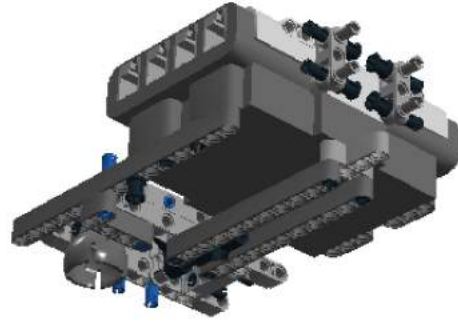

Step 62 of 198

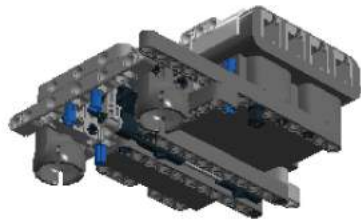
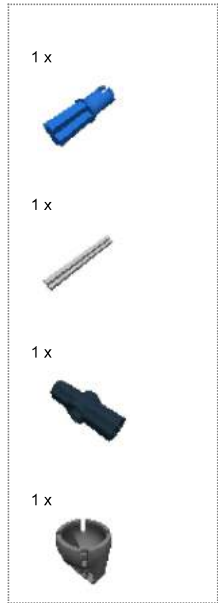

Step 63 of 198



Step 64 of 198

- 1 x 
- 1 x 
- 2 x 

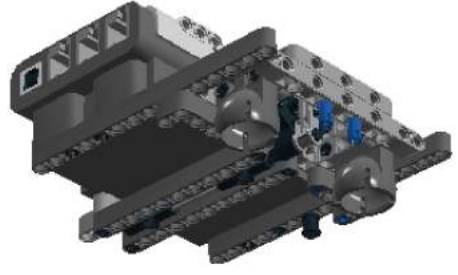

Step 65 of 198

- 1 x 
- 2 x 
- 1 x 



Step 66 of 198

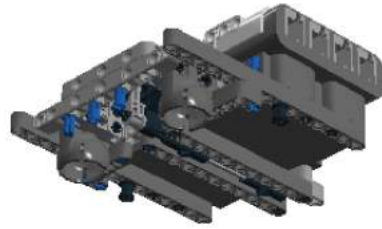
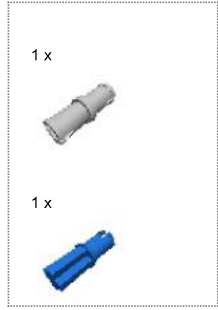

Step 67 of 198

- 1 x 
- 1 x 
- 1 x 
- 1 x 



Step 68 of 198

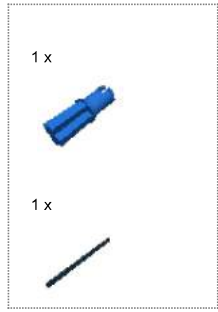



Step 69 of 198

- 1 x 
- 1 x 
- 1 x 
- 1 x 



Step 70 of 198

- 1 x 
- 1 x 
- 1 x 
- 1 x 



Step 71 of 198



Step 72 of 198

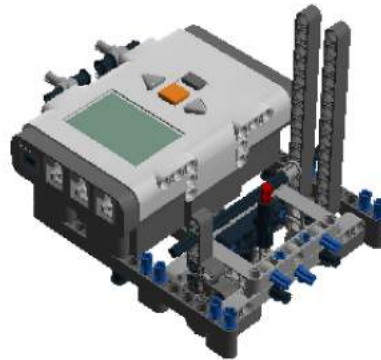
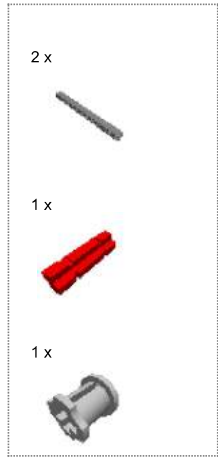

Step 73 of 198

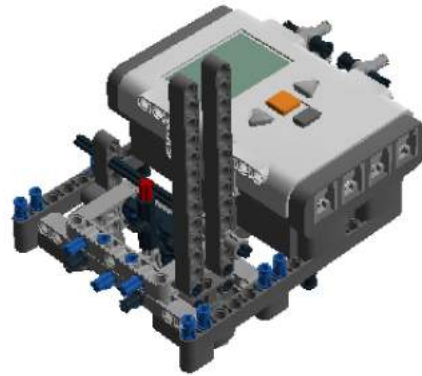

Step 74 of 198



Step 75 of 198

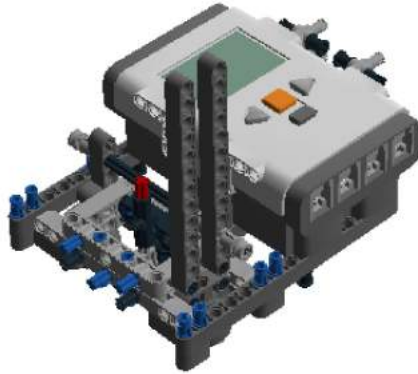

Step 76 of 198

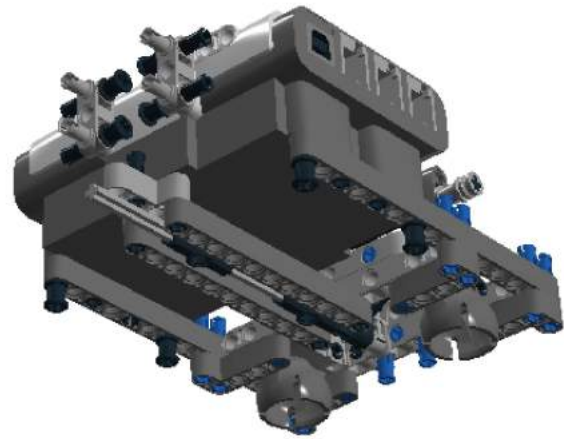

Step 77 of 198

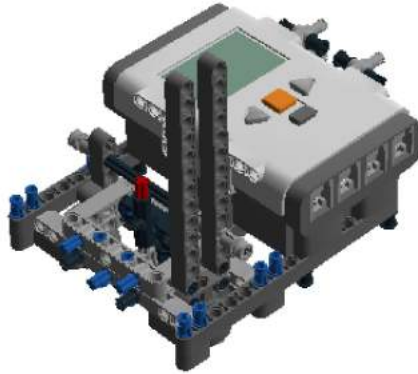

Step 78 of 198

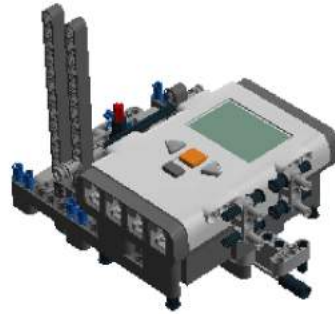

Step 79 of 198

